



TB20 – Digital, Analog, and System Modules

Manual

Version 13 / 1/23/18

Manual order no.: 960-200-0AA01/en

Notes

All rights reserved, including those related to the translation, reprinting, and reproduction of this manual or of parts thereof.

No part of this manual may be reproduced, processed, duplicated, or distributed in any form (photocopy, microfilm, or any other methods), even for training purposes or with the use of electronic systems, without written approval from Helmholz GmbH & Co. KG.

All rights reserved in the event of the granting of a patent or the registration of a utility model.

To download the latest version of this manual, please visit our website at www.helmholz.de.

We welcome all ideas and suggestions.

Copyright © 2018 by
Helmholz GmbH & Co. KG
Hannberger Weg 2, 91091 Großenseebach, Germany

Revision Record

Version	Date	Change
1	10/2/2012	First version
2	10/24/2012	LEDs supplemented; corrections in the specifications; fusing section supplemented;
3	11/16/2012	AO U and AO I parameter sets corrected; electronic nameplate; module ID and module type supplemented
4	2/18/2013	2x / 4x DO 2A added; corrections to the analog values tables
5	7/2/2013	Parameter numbers inserted (section 8)
6	10/22/2013	Relay modules 2x/4x changeover; Di AC 230V; AI U 24V inserted
7	4/24/2014	Corrections UL; AI U/I Iso. & AI TC Iso. inserted
8	8/4/2014	AI and AO: Update times supplemented AI Iso. Modules: Channel LEDs documented
9	6/24/2015	Diagnostic IDs supplemented; DO High Feature modules supplemented Potential distributor 4 x 24 V high feature supplemented Spelling of potential distributor corrected Introduction chapter updated AI TC EA data explained (#5618)
10	10/24/2016	AI R/RTD PT100/PT1000 climate supplemented AI U 100V Iso. supplemented AI U 100V load resistance corrected
11	11/16/2017	DI 8/16 GND reading DO 8/16 sink AI/AO U/I: INT16 format of values UL508 additions
12	12/21/2017	8x / 16x DO, sink current corrected; "Hot-Plug" → "Hot-Swap"
13	1/8/2018	correction of "DO, sink" connection plan text correction for coding plug potential distributor HF: documentation of input area

Table of contents

1.	General.....	10
1.1.	Target audience for this manual	10
1.2.	Safety instructions	10
1.3.	Note symbols and signal words in the manual	11
1.4.	Intended use	12
1.5.	Improper use.....	12
1.6.	Installation.....	13
1.6.1.	Access restriction	13
1.6.2.	Electrical installation	13
1.6.3.	Protection against electrostatic discharges	13
1.6.4.	Overcurrent protection.....	13
1.6.5.	EMC protection	13
1.6.6.	Operation.....	14
1.6.7.	Liability	14
1.6.8.	Disclaimer of liability	14
1.6.9.	Warranty	14
2.	System overview.....	15
2.1.	General.....	15
2.2.	The components that make up the TB20 I/O system	15
2.2.1.	Bus coupler	15
2.2.2.	Peripheral modules	15
2.2.3.	Power and isolation module.....	16
2.2.4.	Power module	17
2.2.5.	Final cover	18
2.2.6.	Components in a module.....	18
2.2.7.	Module Coding.....	19
3.	Installation and removal.....	20
3.1.	Installation position	20
3.2.	Minimum clearance	20
3.3.	Installing and removing peripheral modules	21
3.3.1.	Installation.....	21
3.3.2.	Removal	22
3.4.	Replacing an electronic module.....	25
3.5.	Installing and removing the coupler	29
3.5.1.	Installation.....	29
3.5.2.	Removal	30
3.6.	Installing and removing the final cover	32

3.6.1.	Installation.....	32
3.6.2.	Removal	32
4.	Setup and wiring	33
4.1.	EMC/safety/shielding	33
4.2.	Front connectors	34
4.3.	Wiring the coupler	35
4.4.	Using power and isolation modules	36
4.5.	Separate power supply segments for the coupler and the I/O components.....	37
4.6.	Using power modules.....	38
4.7.	Function of the LEDs.....	39
4.8.	Electronic nameplate.....	39
4.9.	Fusing.....	39
4.10.	General technical specifications	40
5.	Digital modules	41
5.1.	Digital Input Modules	41
5.1.1.	600-210-0AB01, DI 2 x DC 24 V	41
5.1.2.	600-210-0AD01, DI 4 x DC 24 V	42
5.1.3.	600-210-0AH01, DI 8 x DC 24 V	43
5.1.4.	600-210-0AP21, DI 16 x DC 24 V	44
5.1.5.	600-210-0DH01, DI 8 x 24 V GND reading.....	45
5.1.6.	600-210-0DP21, DI 16 x 24 V GND reading	46
5.1.7.	600-210-0CC01, DI 3 x DC 24 V, 3-wire	47
5.1.8.	600-210-0CF21, DI 6 x DC 24 V, 3-wire.....	48
5.1.9.	600-211-0BB01, DI 2 x AC 230 V, per channel N	49
5.1.10.	600-211-0BD01, DI 4 x AC 230 V, per channel N.....	50
5.1.11.	600-211-0BH21, DI 8 x AC 230 V, per channel N.....	51
5.2.	Digital output modules	52
5.2.1.	600-220-0AB01, DO 2 x DC 24 V, 500 mA	52
5.2.2.	600-220-0AD01, DO 4 x DC 24 V, 500 mA.....	53
5.2.3.	600-220-0AH01, DO 8 x DC 24 V, 500 mA.....	54
5.2.4.	600-220-0AP21, DO 16 x DC 24 V, 500 mA.....	55
5.2.5.	600-220-0DH01, DO 8 x DC 24 V, 300 mA, sink.....	56
5.2.6.	600-220-0DP21, DO 16 x DC 24 V, 300 mA, sink.....	57
5.2.7.	600-220-7AD01, DO 4 x DC 24 V, 700 mA, High Feature	58
5.2.8.	600-220-7AH01, DO 8 x DC 24 V, 700 mA, High Feature	60
5.2.9.	600-220-7AP21, DO 16 x DC 24 V, 700 mA, High Feature	62
5.2.10.	600-220-0BB01, DO 2 x DC 24 V, 2 A.....	64
5.2.11.	600-220-0BD01, DO 4 x DC 24 V, 2 A	65
5.2.12.	600-222-0AB01, DO 2 x relay, AC 230 V, 5 A, changeover.....	66

5.2.13.	600-222-0AD21, DO 4 x relay, AC 230 V, 5 A, changeover	67
5.3.	Digital Input/Output Modules.....	69
5.3.1.	600-230-0AD01, DIO 2 x In / 2 x Out DC 24 V, 500 mA.....	69
5.3.2.	600-230-0AH01, DIO 4 x In / 4 x Out DC 24 V, 500 mA.....	71
5.3.3.	600-230-0AP21, DIO 8 x Out / 8 x In DC 24 V, 500 mA	73
6.	Analog modules	75
6.1.	Analog Input Modules.....	75
6.1.1.	600-250-4AB01, AI 2 x I, 0/4-20 mA, ±20 mA, 12-bit	75
6.1.2.	600-250-4AD01, AI 4 x I, 0/4-20 mA, ±20 mA, 12-bit.....	77
6.1.3.	600-250-7BB01, AI 2 x I, 0/4-20 mA, ±20 mA, Iso., 16-bit.....	79
6.1.4.	600-250-7BD01, AI 4 x I, 0/4-20 mA, ±20 mA, Iso., 16-bit	81
6.1.5.	600-250-7BH21, AI 8 x I, 0/4-20 mA, ±20 mA, Iso., 16-bit	83
6.1.6.	600-252-4AB01, AI 2 x U, ±10 V, 0–10 V, 1–5 V, 12-bit.....	85
6.1.7.	600-252-4AD01, AI 4 x U, ±10 V, 0–10 V, 1–5 V, 12-bit	87
6.1.8.	600-252-7BB01, AI 2 x U, ±10 V, 0–10 V, 1–5 V, Iso., 16-bit	89
6.1.9.	600-252-7BD01, AI 4 x U, ±10 V, 0-10 V, 1-5 V, Iso., 16-bit.....	91
6.1.10.	600-252-7BH21, AI 8 x U, ±10 V, 0–10 V, 1–5 V, Iso., 16-bit.....	93
6.1.11.	600-252-4CB01, AI 2 x U, ±24 V, 0–24 V, 12-bit.....	95
6.1.12.	600-252-4CD01, AI 4 x U, ±24 V, 0–24 V, 12-bit	97
6.1.13.	600-252-7DD01, AI 4 x U, ±100 V, 0-100 V, Iso., 16 bit	99
6.1.14.	600-252-7DH21, AI 8 x U, ±100 V, 0-100 V, Iso., 16 bit	101
6.1.15.	600-253-4AB01, AI 1/2 x R, RTD, 16-bit, 2/3/4-wire	103
6.1.16.	600-253-4AD01, AI 2/4 x R, RTD, 16-bit, 2/3/4-wire	105
6.1.17.	600-254-4AB01, AI 2 x TC, 16-bit.....	107
6.1.18.	600-254-4AD01, AI 4 x TC, 16-bit	110
6.1.19.	600-254-4AB02, AI 2 x TC, Iso., 16-bit	113
6.1.20.	600-254-4AD02, AI 4 x TC, Iso., 16-bit	116
6.1.21.	600-254-4AH22, AI 8 x TC, Iso., 16-bit	119
6.2.	Analog Output Modules.....	122
6.2.1.	600-260-4AB01, AO 2 x I, 0/4–20 mA, 12-bit.....	122
6.2.2.	600-260-4AD01, AO 4 x I, 0/4-20 mA, 12-bit.....	124
6.2.3.	600-261-4AB01, AO 2 x U, ±10 V, 0–10 V, 1–5 V, 12-bit	126
6.2.4.	600-261-4AD01, AO 4 x U, ±10 V, 0–10 V, 1–5 V, 12-bit.....	128
6.3.	Basic Analog Value Representation Principles.....	130
6.3.1.	General Information.....	130
6.3.2.	Analog Value Representation with 16-bit Resolution	130
6.3.3.	Reading Resolution	130
6.4.	Analog Value Representation in SIMATIC S7 Format	131
6.4.1.	Simatic S7 Analog Value Representation for Voltage Measuring Ranges.....	131
6.4.2.	Simatic S7 Analog Value Representation for Current Measuring Ranges	133

6.4.3.	Simatic S7 Analog Value Representation for Resistance Measuring Range.....	134
6.4.4.	Analog value representation for PT100/PT1000 Standard	135
6.4.5.	Analog value representation for Ni100/Ni1000/LGNi1000 Standard.....	135
6.4.6.	Analog value representation for PT100/PT1000 climate.....	136
6.4.7.	Analog Value Representation for TC	136
6.5.	Analog Value Representation in SIMATIC S5 Format	137
6.5.1.	Simatic S5 Analog Value Representation for Voltage Measuring Ranges.....	137
6.5.2.	Simatic S5 Analog Value Representation for Current Measuring Ranges	138
6.5.3.	Simatic S5 Analog Value Representation for Resistance Measuring Range.....	139
6.6.	Analog Value Representation in INT16 Format	140
6.6.1.	INT16 Analog Value Representation for Voltage Measuring Ranges	140
6.6.2.	INT16 Analog Value Representation for Current Measuring Ranges.....	141
6.7.	Definition of Operational Error Limit and Basic Error Limit.....	142
6.7.1.	Operational error limit	142
6.7.2.	Basic error limit.....	142
6.7.3.	Example Showing How to Calculate the Input Error for an Analog Input Module	142
6.8.	Connecting Sensors to Analog Inputs	143
6.8.1.	Abbreviations Used.....	143
6.8.2.	Signal Cables.....	143
6.8.3.	Connecting Voltage Transmitters	144
6.8.4.	Connecting Current Transmitters	145
6.8.5.	Connecting Resistance Thermometers and Resistors.....	146
6.8.6.	Connecting Thermocouples	147
6.9.	Connecting Loads and Actuators to Analog Outputs	148
6.9.1.	Abbreviations Used.....	148
6.9.2.	Connecting Loads/Actuators to Voltage Outputs	148
6.9.3.	Connecting Loads/Actuators to Current Outputs.....	149
7.	System Components.....	150
7.1.	Power and isolation modules.....	150
7.1.1.	600-710-0AA01, 24 VDC, 8 A Power and Isolation Module	150
7.2.	Potential Distributors	151
7.2.1.	600-730-4AD01, potential distributor 4 x DC 24 V, High Feature.....	151
7.2.2.	600-720-0AH01, potential distributor 9 x DC 24 V	152
7.2.3.	600-720-0BH01, 9 x GND Potential Distributor.....	153
7.2.4.	600-720-0CH01, 10 x AUX Potential Distributor.....	154
7.2.5.	600-720-0DH01, potential distributor 4 x DC 24 V + 4 x GND.....	155
7.2.6.	600-720-0XH01, 9 x Free Pot. distributor.....	156
7.3.	Power supply	157
7.3.1.	600-700-0AA01, 24 VDC Power Module	157

8.	Configuring the Modules' Parameters.....	159
8.1.	General Information	159
8.2.	Digital Output Modules	159
8.2.1.	600-220-7AD01, DO 4 x DC 24 V, 700 mA, High Feature	159
8.2.2.	600-220-7AH01, DO 8 x DC 24 V, 700 mA, High Feature	160
8.2.3.	600-220-7AP21, DO 16 x DC 24 V, 700 mA, High Feature	160
8.2.4.	Work method of pulse extension for DO high feature modules	161
8.3.	Analog Input Modules.....	162
8.3.1.	600-250-4AB01, AI 2x I, 0/4–20 mA, +20 mA, 12-bit.....	162
8.3.2.	600-250-4AD01, AI 4 x I, 0/4–20 mA, ±20 mA, 12-bit	163
8.3.3.	600-250-7BB01, AI 2x I, 0/4–20 mA, +20 mA, Iso., 16-bit	164
8.3.4.	600-250-7BD01, AI 4x I, 0/4–20 mA, +20 mA, Iso., 16-bit.....	165
8.3.5.	600-250-7BH21, AI 8x I, 0/4-20 mA, +20 mA, Iso., 16-bit	166
8.3.6.	600-252-4AB01, AI 2 x U, ±10 V, 0–10 V, 1–5 V, 12-bit.....	168
8.3.7.	600-252-4AD01, AI 4 x U, ±10 V, 0–10 V, 1–5 V, 12-bit	169
8.3.8.	600-252-7BB01, AI 2x U, +10 V, 0–10 V, 1–5 V, Iso., 16-bit	170
8.3.9.	600-252-7BD01, AI 4x U, +10 V, 0–10 V, 1–5 V, Iso., 16-bit.....	171
8.3.10.	600-252-7BH21, AI 8x U, +10 V, 0–10 V, 1–5 V, Iso., 16-bit	172
8.3.11.	600-252-4CB01, AI 2x U, +24 V, 0–24 V, 12-bit.....	174
8.3.13.	600-252-4CD01, AI 4x U, +24 V, 0–24 V, 12-bit	175
8.3.14.	600-252-7DD01, AI 4x U, +100 V, 0-100 V, Iso., 16-bit.....	176
8.3.15.	600-252-7DH21, AI 8x U, +100 V, 0-100 V, Iso., 16-bit.....	177
8.3.16.	600-253-4AB01, AI 1/2 x R, RTD, 16-bit, 2/3/4-wire	179
8.3.17.	600-253-4AD01, AI 2/4x R, RTD, 16-bit, 2/3/4-wire	180
8.3.18.	600-254-4AB01, AI 2 x TC, 16-bit.....	182
8.3.19.	600-254-4AB02, AI 2 x TC, Iso., 16-bit	182
8.3.20.	600-254-4AD01, AI 4 x TC, 16-bit	183
8.3.21.	600-254-4AD02, AI 4 x TC, Iso., 16-bit	183
8.3.22.	600-254-4AH22, AI 8 x TC, Iso., 16-bit	184
8.4.	Analog Output Modules.....	186
8.4.1.	600-260-4AB01, AO 2 x I, 0/4–20 mA, 12-bit.....	186
8.4.2.	600-260-4AD01, AO 4 x I, 0/4–20 mA, 12-bit	187
8.4.3.	600-261-4AB01, AO 2x U, +10 V, 0–10 V, 1–5 V, 12-bit	188
8.4.4.	600-261-4AD01, AO 4 x U, ±10 V, 0–10 V, 1–5 V, 12-bit.....	189
9.	Alarms	190
9.1.	Diagnostic IDs	190
9.2.	Process alarms.....	190
9.2.1.	Process alarms of the analog input modules	190
10.	Dimensions	191

11.	Spare parts	192
11.1.	Base modules	192
11.1.1.	14 mm width standard base module.....	192
11.1.2.	25 mm width base module.....	192
11.1.3.	Power and isolation base module.....	192
11.1.4.	Power base module	193
11.2.	Front connectors	193
11.2.1.	10-terminal front connector.....	193
11.2.2.	20-terminal front connector.....	193
11.3.	Electronic modules	194
11.4.	Final cover	194

1. General

This operating manual applies only to devices, assemblies, software, and services of Helmholtz GmbH & Co. KG.

1.1. Target audience for this manual

This description is only intended for trained personnel qualified in control and automation engineering who are familiar with the applicable national standards. For installation, commissioning, and operation of the components, compliance with the instructions and explanations in this operating manual is essential.



Configuration, execution, and operating errors can interfere with the proper operation of the TB20 devices and result in personal injury as well as material or environmental damage. Only suitably qualified personnel may operate the TB20 devices!

Qualified personnel must ensure that the application and use of the products described meet all the safety requirements, including all relevant laws, regulations, provisions, and standards.

1.2. Safety instructions

The safety instructions must be observed in order to prevent harm to persons and living creatures, material goods, and the environment. The safety instructions indicate possible hazards and provide information on how hazardous situations can be prevented.

1.3. Note symbols and signal words in the manual



HAZARD

If the hazard warning is ignored, there is an imminent danger to life and health of people from electrical voltage.



WARNING

If the hazard warning is ignored, there is a probable danger to life and health of people from electrical voltage.



CAUTION

If the hazard warning is ignored, people can be injured or harmed.



ATTENTION

Draws attention to sources of error that can damage equipment or the environment.



NOTE

Gives an indication for better understanding or preventing errors.

1.4. Intended use

The TB20 I/O system is an open, modular, and distributed peripheral system designed to be mounted on a 35 mm DIN rail.

Communication with a higher-level control system takes place via a bus system / network through a TB20 bus coupler. Up to 64 modules from the TB20 range can be set up on a bus coupler. The bus couplers support hot plug for replacing modules during ongoing operation.

All components are supplied with a factory hardware and software configuration. The user must carry out the hardware and software configuration for the conditions of use. Modifications to hardware or software configurations which are beyond the documented options are not permitted and nullify the liability of Helmholtz GmbH & Co. KG.

The TB20 devices should not be used as the only means for preventing hazardous situations on machinery and equipment.

Successful and safe operation of the TB20 devices requires proper transport, storage, installation, assembly, installation, commissioning, operation, and maintenance.

The ambient conditions provided in the technical specifications must be adhered to.

The TB20 systems have a protection rating of IP20 and must have a control box/cabinet fitted to protect against environmental influences in an electrical operating room. To prevent unauthorized access, the doors of control boxes/cabinets must be closed and possibly locked during operation.



TB20 devices can be equipped with modules that can carry dangerously high voltages. The voltages connected to the TB20 devices can result in hazards during work on the TB20 devices.

1.5. Improper use



The consequences of improper use may include injury of the user or third parties, as well as property damage to the control system, the product, or environment. Use TB20 devices only as intended!

1.6. Installation

1.6.1. Access restriction

The modules are open operating equipment and must only be installed in electrical equipment rooms, cabinets, or housings.

Access to the electrical equipment rooms, cabinets, or housings must only be possible using a tool or key, and access should only be granted to trained or authorized personnel.

1.6.2. Electrical installation

Observe the regional safety regulations.



HAZARD

TB20 devices can be equipped with modules that can carry dangerously high voltages. The voltages connected to the TB20 devices can result in hazards during work on the TB20 devices.

1.6.3. Protection against electrostatic discharges

To prevent damage through electrostatic discharges, the following safety measures are to be followed during assembly and service work:

- Never place components and modules directly on plastic items (such as polystyrene, PE film) or in their vicinity.
- Before starting work, touch the grounded housing to discharge static electricity.
- Only work with discharged tools.
- Do not touch components and assemblies on contacts.

1.6.4. Overcurrent protection

To protect the TB20 and the supply line, a slow-blowing 8 A line protection fuse is required.

1.6.5. EMC protection

To ensure electromagnetic compatibility (EMC) in your control cabinets in electrically harsh environments, the known rules of EMC-compliant configuration are to be observed in the design and construction.

1.6.6. Operation

Operate the TB20 only in flawless condition. The permissible operating conditions and performance limits must be adhered to.

Retrofits, changes, or modifications to the device are strictly forbidden.

The TB20 is an operating means intended for use in industrial plants. During operation, the TB20 can carry dangerous voltages. During operation, all covers on the unit and the installation must be closed in order to ensure protection against contact.

1.6.7. Liability

The contents of this manual are subject to technical changes resulting from the continuous development of products of Helmholtz GmbH & Co. KG. In the event that this manual contains technical or clerical errors, we reserve the right to make changes at any time without notice. No claims for modification of delivered products can be asserted based on the information, illustrations, and descriptions in this documentation. Beyond the instructions contained in the operating manual, the applicable national and international standards and regulations must also in any case be observed.

1.6.8. Disclaimer of liability

Helmholtz GmbH & Co. KG is not liable for damages if these were caused by use or application of products that was improper or not as intended.

Helmholtz GmbH & Co. KG assumes no responsibility for any printing errors or other inaccuracies that may appear in the operating manual, unless there are serious errors about which Helmholtz GmbH & Co. KG was already demonstrably aware.

Beyond the instructions contained in the operating manual, the applicable national and international standards and regulations must also in any case be observed.

Helmholtz GmbH & Co. KG is not liable for damage caused by software that is running on the user's equipment which compromises, damages, or infects additional equipment or processes through the remote maintenance connection and which triggers or permits unwanted data transfer.

1.6.9. Warranty

Report any defects to the manufacturer immediately after discovery of the defect.

The warranty is not valid in case of:

- Failure to observe these operating instructions
- Use of the device that is not as intended
- Improper work on and with the device
- Operating errors
- Unauthorized modifications to the device

The agreements met upon contract conclusion under "General Terms and Conditions of Helmholtz GmbH & Co. KG" apply.

2. System overview

2.1. General

The TB20 I/O system is an open, modular, and distributed peripheral system designed to be mounted on a 35mm DIN rail.

It is made up of the following components:

- Bus couplers
- Peripheral modules
- Power and isolation modules
- Power modules

By using these components, you can build a custom automation system that is tailored to your specific needs and that can have up to 64 modules connected in series to a bus coupler. All components have a protection rating of IP20.

2.2. The components that make up the TB20 I/O system

2.2.1. Bus coupler

The system's bus coupler includes a bus interface and a power module. The bus interface is responsible for establishing a connection to the higher-level bus system and is used to exchange I/O signals with the automation system's CPU.

The power module is responsible for powering the coupler's electronics and all connected peripheral modules.

2.2.2. Peripheral modules

The system's peripheral modules are electronic components to which peripheral devices such as sensors and actuators can be connected. A variety of peripheral modules with different tasks and functions are available.

Example: Peripheral module with 10-pin front connector



Example: Peripheral module with 20-pin front connector

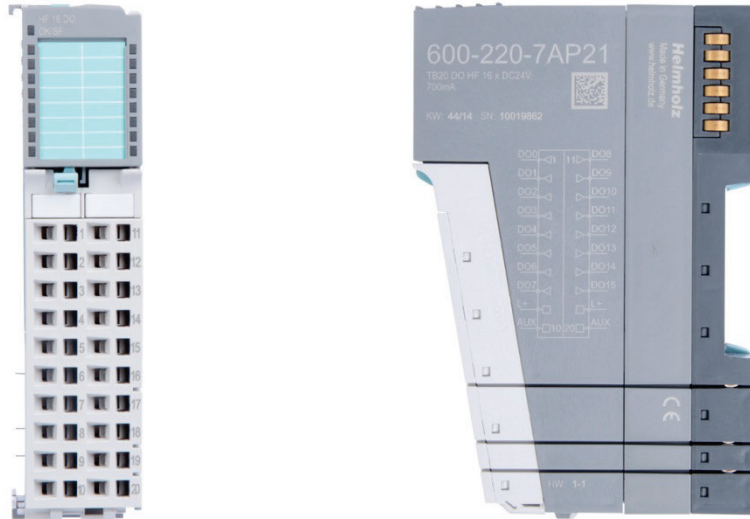

2.2.3. Power and isolation module

The system's bus coupler provides the supply voltage for the communications bus (5 V, top) and for external signals (24 V, bottom). These voltages are passed from module to module through the base modules.

Power and isolation modules make it possible to segment the power supply for external signals into individual power supply sections that are powered separately. On the other hand, the communications bus signals and supply voltage for the communications bus are simply passed through, in contrast to the way they are handled in the power modules (see section 2.2.4).



NOTE

Power and insulation modules have a lighter body color.

2.2.4. Power module

The system's bus coupler provides the supply voltage for the communications bus (5 V, top) and for external signals (24 V, bottom). These voltages are passed from module to module through the base modules.

Power modules make it possible to segment the power supply for both external signals and the communication bus into individual power supply sections that are powered separately.

Power modules deliver all necessary power to the peripheral modules connected after them and, if applicable, all the way to the next power module or power and isolation module. A power module is required whenever the power supplied by the coupler alone is not sufficient, e.g., when there are a large number of modules with high power requirements. The "TB20 ToolBox" configuration program can be used to determine whether power modules are needed, as well as how many of them will be needed.



NOTE

Power modules have a lighter body color.

2.2.5. Final cover

The final cover protects the contacts on the last base module from accidental contact by covering its outer right-hand side.

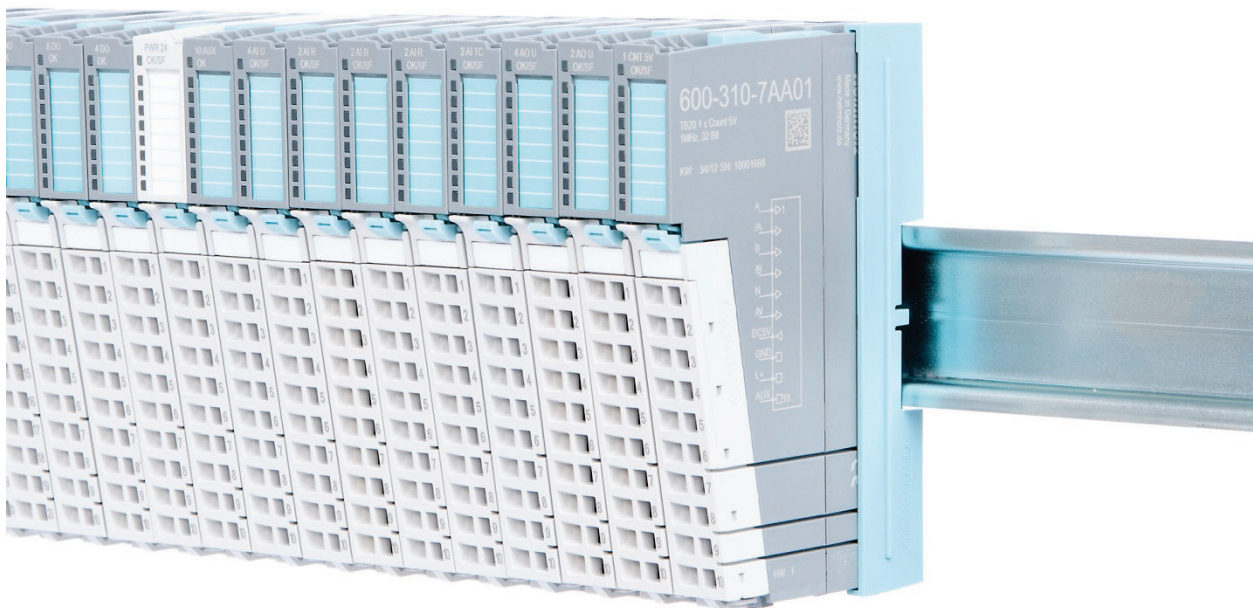

2.2.6. Components in a module

Each module consists of three parts:

- A base module
- An electronic module
- A front connector



2.2.7. Module Coding

Electronic modules and base modules feature coding elements meant to prevent the wrong spare electronic modules from being plugged in during maintenance and repairs.

These coding elements consist of a coding plug on the electronic module and a coding socket on the base module (see following figure).

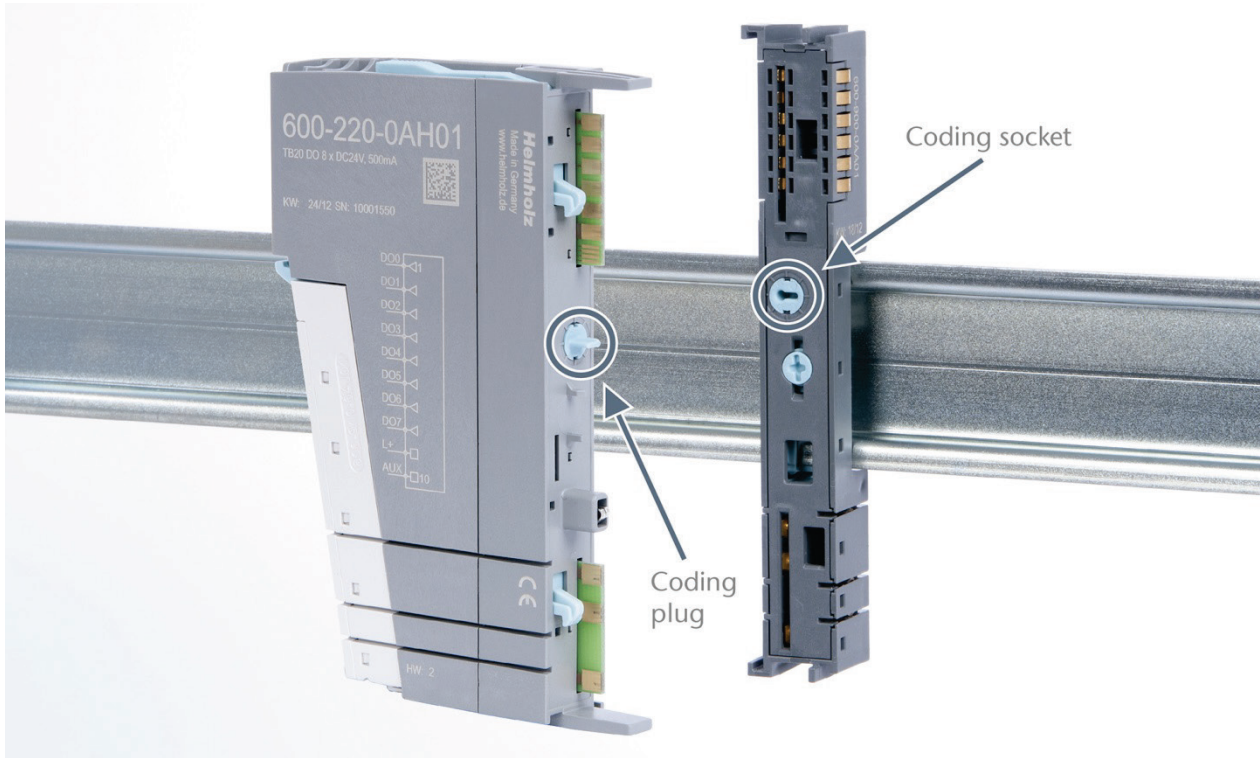

The coding plug and coding socket can each be in one of eight different positions. Each of these eight positions can be used for a specific type of module (Digital In, Digital Out, Analog In, Analog Out, Power). It will only be possible to plug an electronic module into a base module if the position of the coding plug and the position of the coding socket match. If the positions differ, the electronic module is mechanically blocked.

3. Installation and removal



HAZARD

TB20 modules can carry lethal voltage.

Before starting any work on TB20 system components, make sure to de-energize all components and the cables supplying them with power! Carrying out work when the system is live poses the risk of fatal electrocution!



ATTENTION

Installation must be carried out according to VDE 0100/IEC 364 and in accordance with applicable national standards. The TB20 IO system has protection rating IP20. If a higher protection rating is required, the system must be installed in a housing or control cabinet. In order to ensure safe operation, the ambient temperature must not exceed 60 °C.

3.1. Installation position

The TB20 I/O system can be installed in any position.

Optimal ventilation and thus the maximum ambient temperature can only be achieved in the horizontal installation layout.

3.2. Minimum clearance

It is recommended to adhere to the minimum clearances specified when installing the coupler and modules. Adhering to these minimum clearances will ensure that:

- the modules can be installed and removed without having to remove any other system components
- there will be enough space to make connections to all existing terminals and contacts using commercially available accessories.
- there will be enough space for potentially necessary cable management systems.

The minimum clearances for mounting TB20 components are: 30 mm on the top and on bottom and 10 mm on each side.

3.3. Installing and removing peripheral modules

3.3.1. Installation

Installing an assembled peripheral module

Place the assembled module on the DIN rail by moving it straight towards the rail. Make sure that the module engages the upper and lower guide elements of the previous module. Then push the upper part of the module towards the DIN rail until the rail fastener fastens into place on the inside snaps with a soft click.

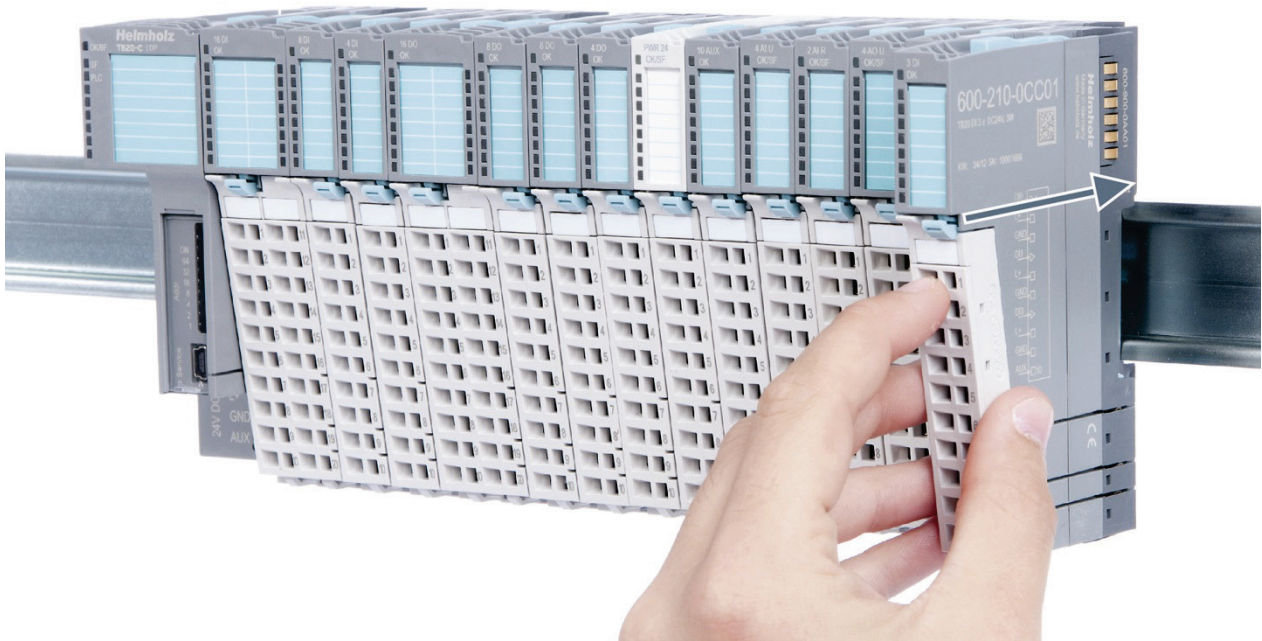

Installing the individual parts of a peripheral module one after the other:

Place the base module on the DIN rail from below in an inclined position. Then push the upper part of the base module towards the rail until the module is parallel to the rail and the rail fastener on the inside snaps into place with a soft click.

Place an electronic module with matching coding (see “Module Coding” in section 2.2.7) on the base module in a straight line from above and then gently push it onto the base module until both modules are fully resting on top of one another and the module fastener snaps into place with a soft click.

Finally, place the front connector on the electronic module from below in an inclined position and then gently push it onto the electronic module until the front connector fastener snaps into place with a soft click.

3.3.2. Removal

To remove a peripheral module, follow the four steps below:

Step 1: Remove the front connector

To remove the front connector, push the tab above the front connector upwards (see the picture below). This will push out the front connector, after which you can pull it out.

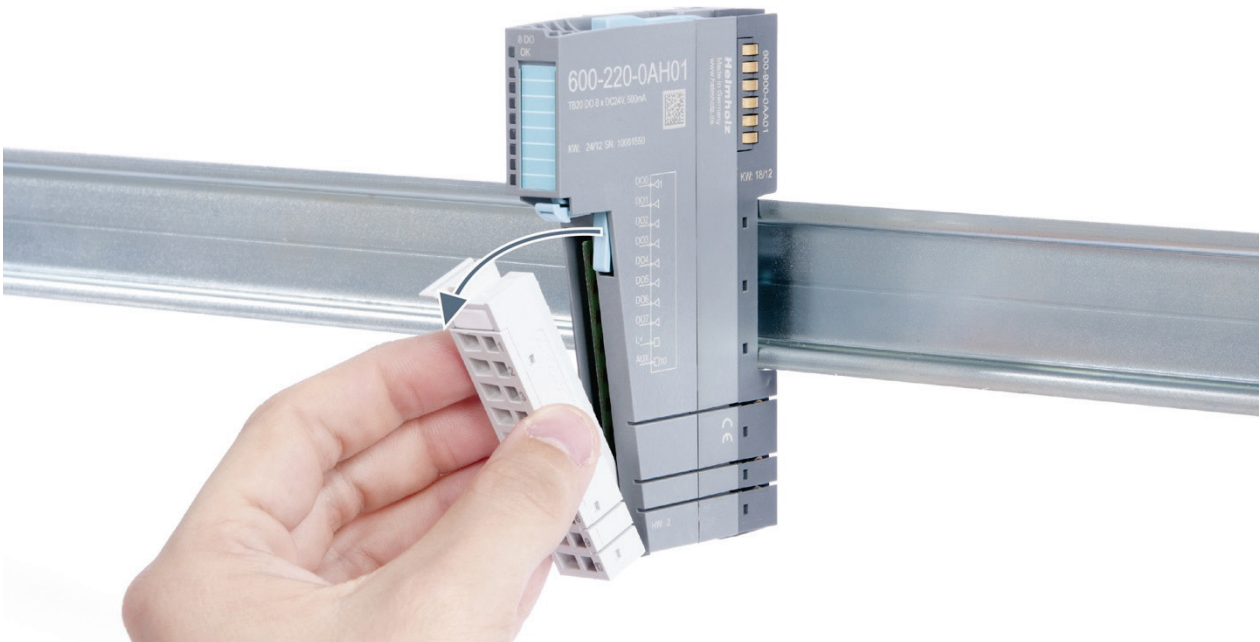
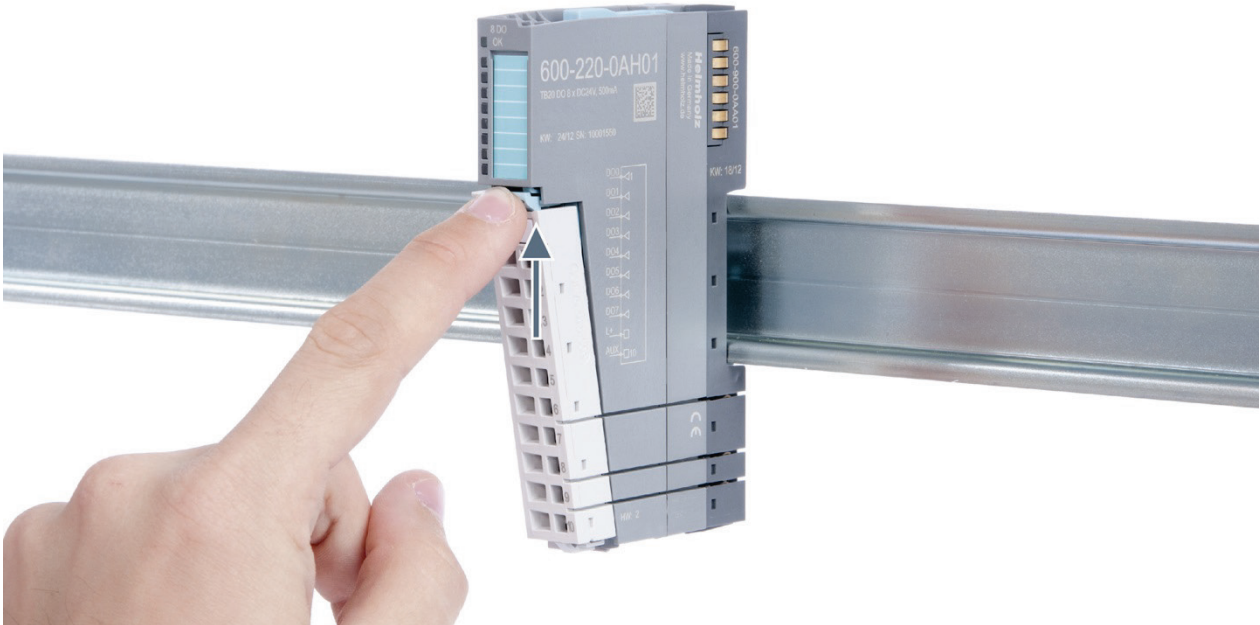

Step 2: Remove the electronic module

To do so, use your middle finger to push on the lever from above and then use your thumb and index finger to pull out the electronic module while holding the lever down (see the picture below).

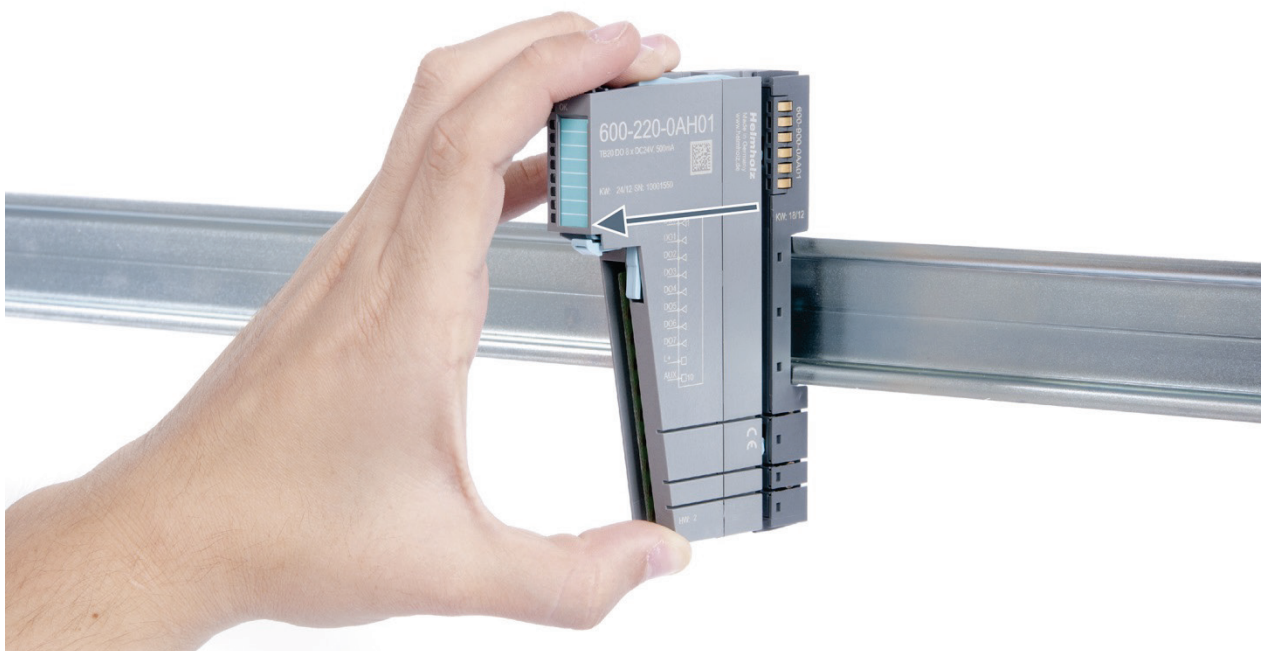
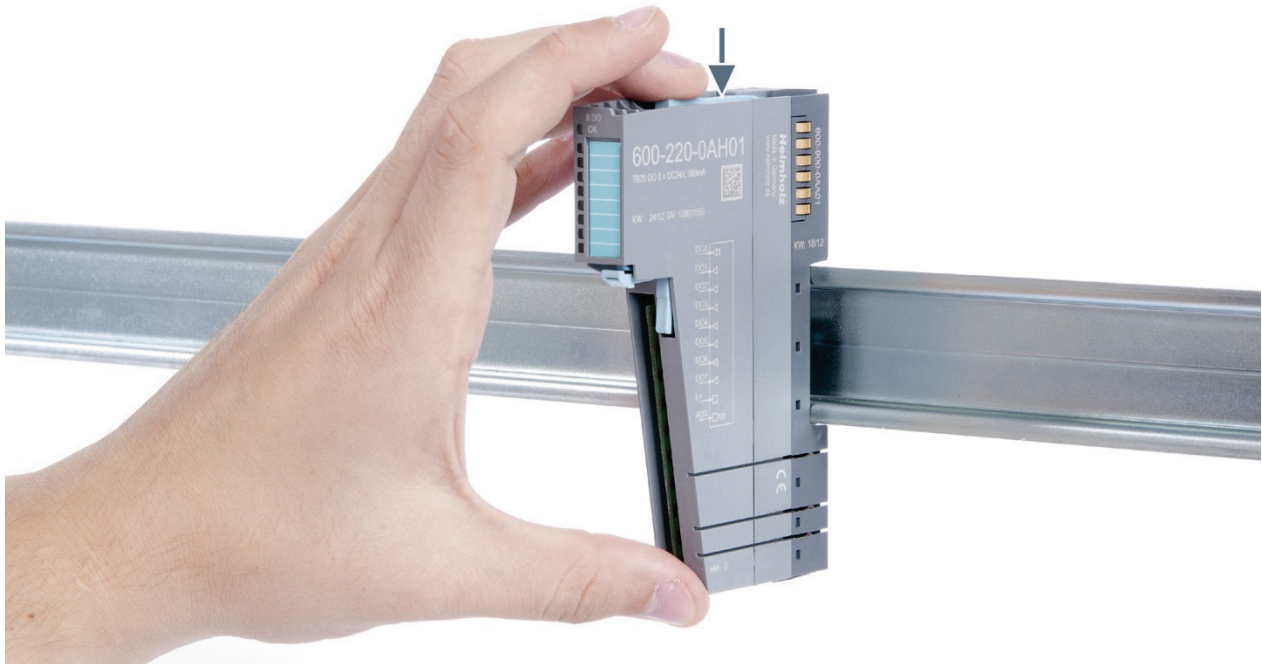

Step 3: Release the base module

Use a screwdriver to release the base module. Turn the screwdriver 90° counterclockwise to release.

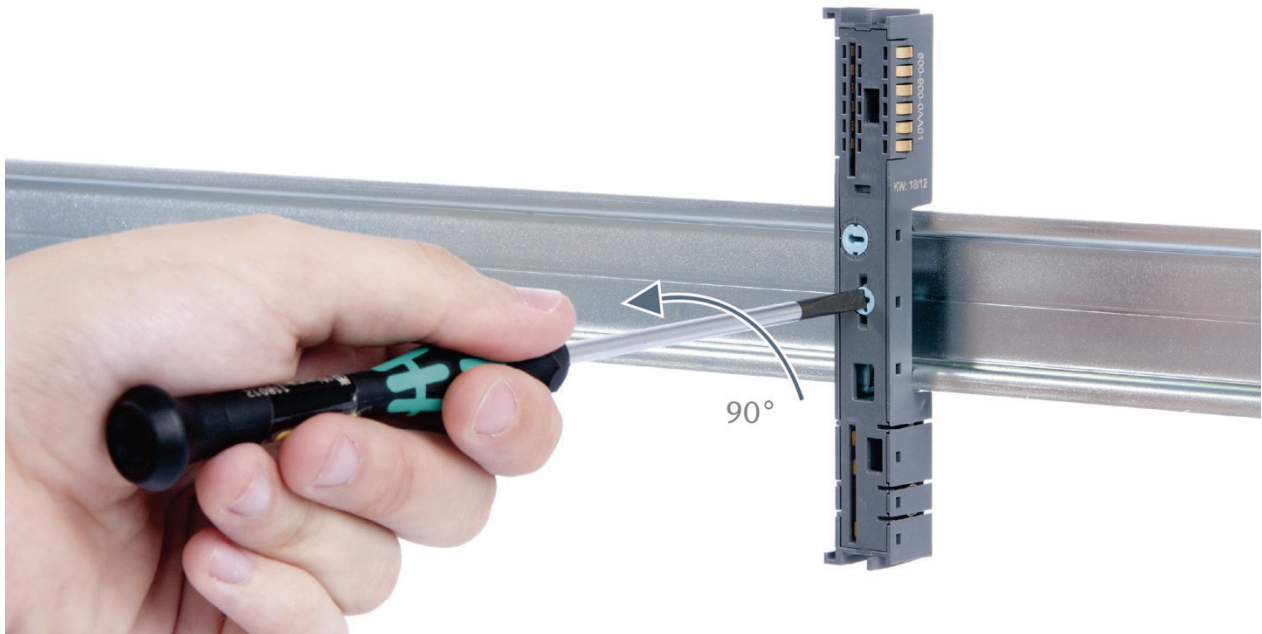

Step 4: Remove the base module

Remove the base module by pulling it towards you.

3.4. Replacing an electronic module

The procedure for replacing the electronic module on a peripheral module consists of four steps.

If you need to replace the electronic module while the system is running, make sure to take into account the general technical specifications for the bus coupler being used.



HAZARD

TB20 modules can carry lethal voltage.

Before starting any work on TB20 system components, make sure to de-energize all components and the cables supplying them with power! Carrying out work when the system is live poses the risk of fatal electrocution!

Note the wiring diagram of the system and switch off dangerous voltages before starting work!

Step 1: Remove the front connector

To remove the front connector, push the tab above the front connector upwards (see the picture below). This will push out the front connector, after which you can pull it out.

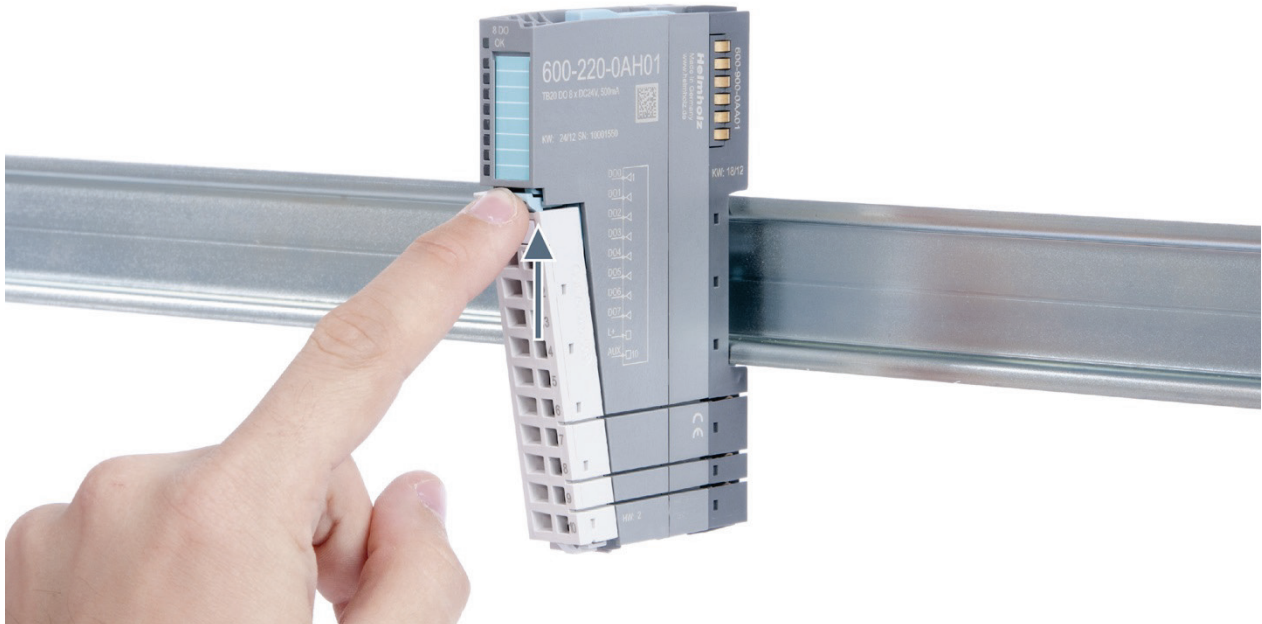

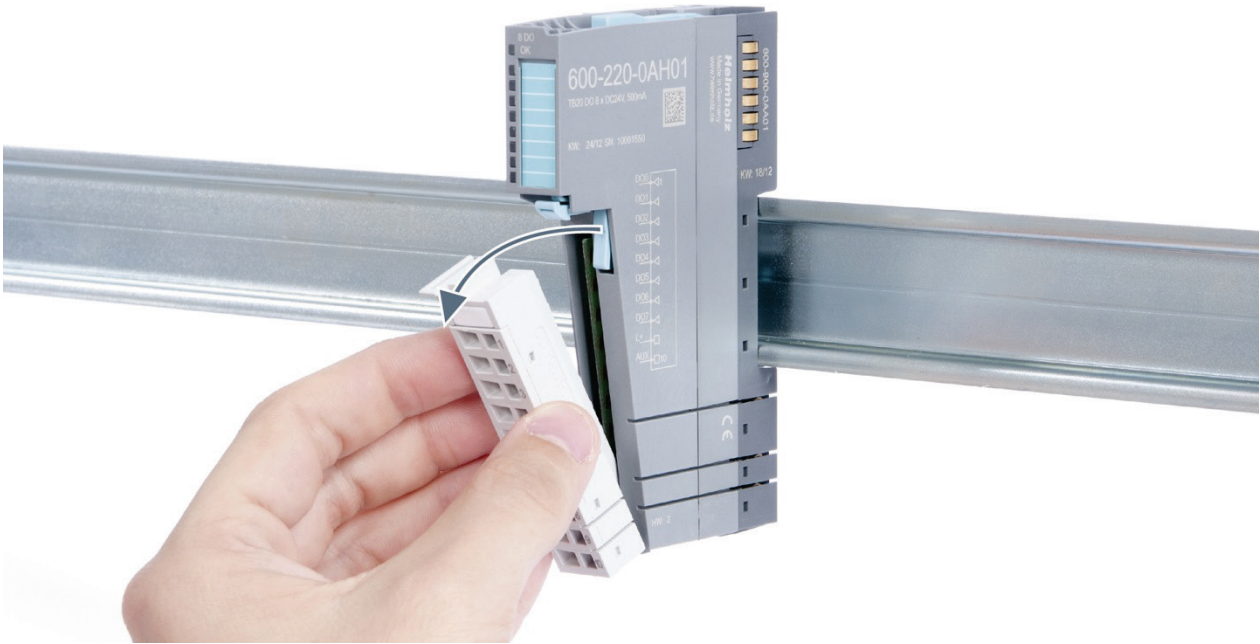

Step 2: Remove the electronic module

To remove the electronic module, use your middle finger to push on the lever from above and then use your thumb and index finger to pull out the electronic module while holding the lever down (see the picture below).

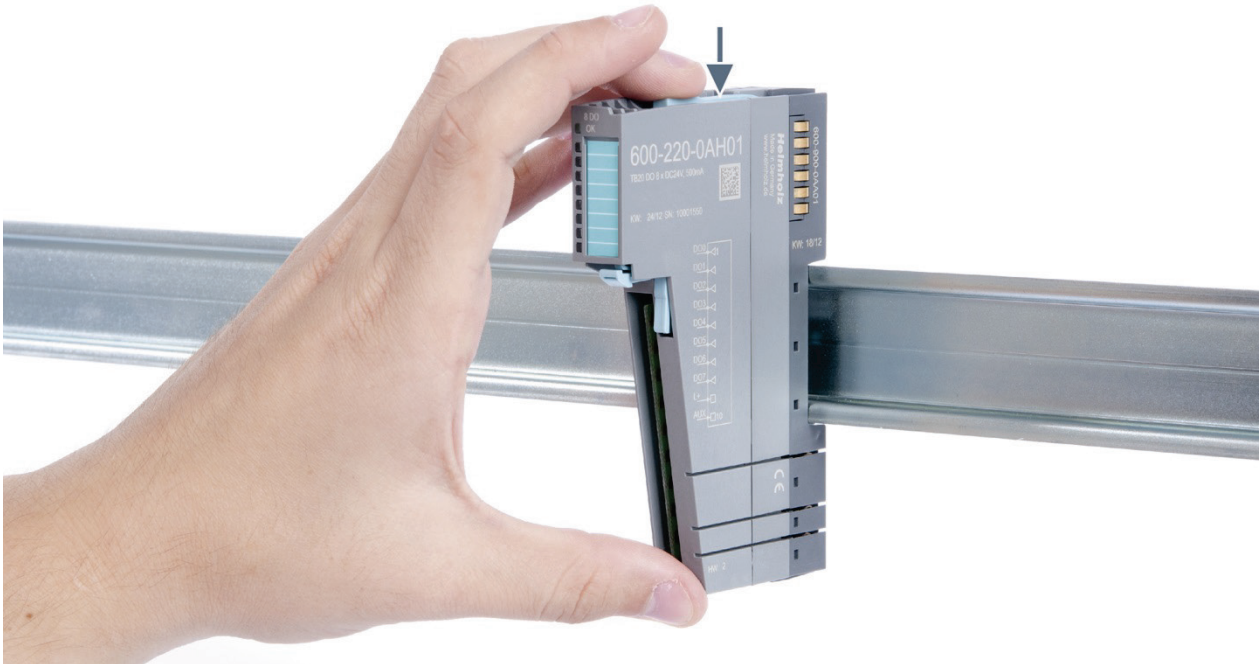

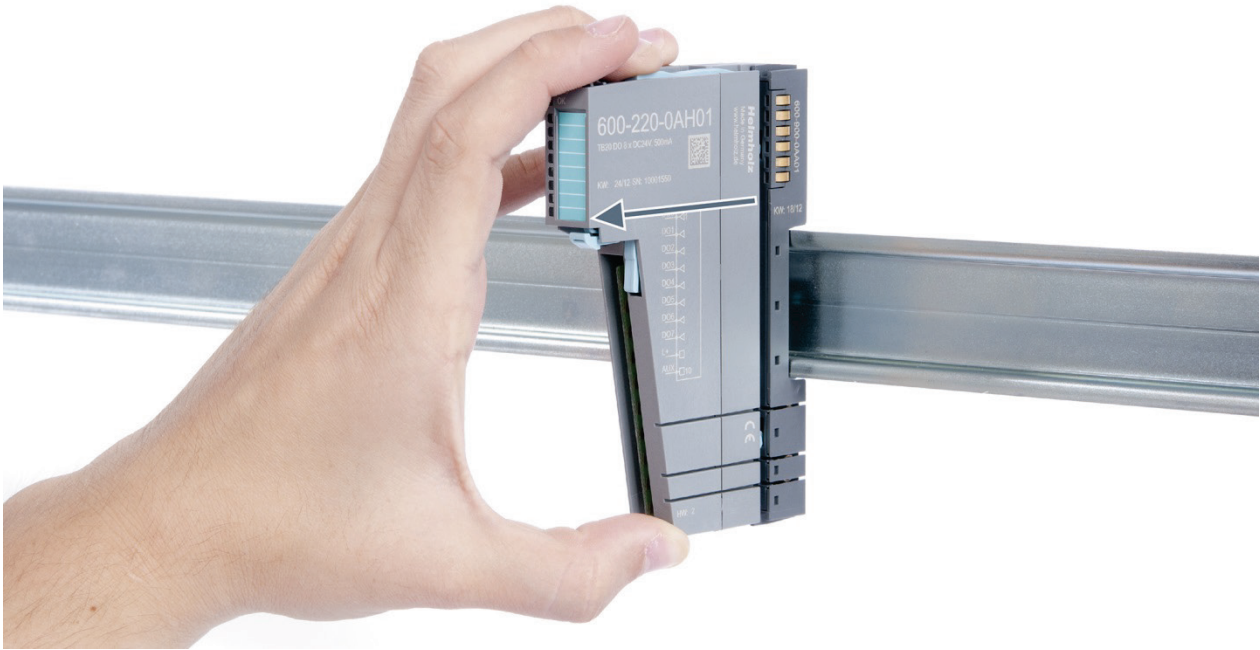

Step 3: Plug in a new electronic module



ATTENTION

The electronic module must be snapped into place on the base module with a single continuous movement. If the electronic module is not snapped into place firmly and straight on the base module, bus malfunctions may occur.



ATTENTION

If the electronic module cannot be plugged into the base module, check whether the coding elements on the electronic module and base module (see figure below) match. If the coding elements on the electronic module do not match those on the base module, you may be attempting to plug in the wrong electronic module.

For more information on coding elements, please consult section 2.2.7.

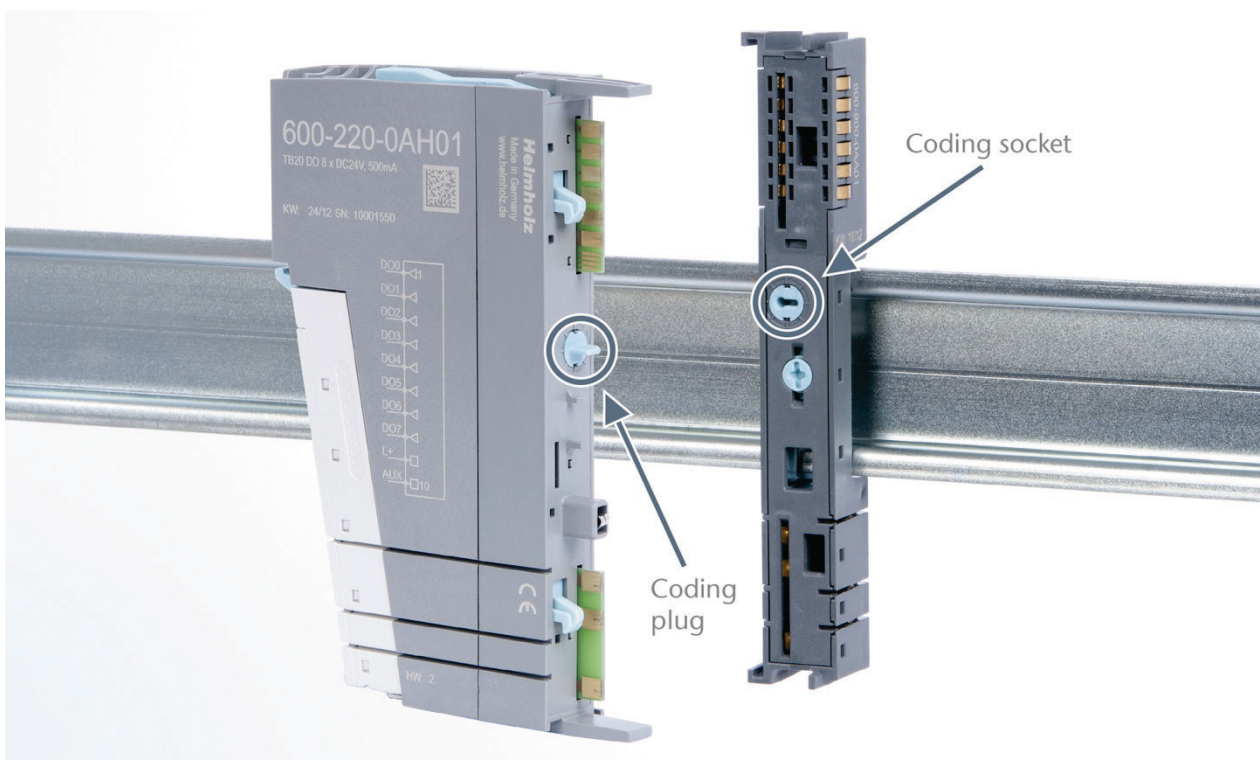

Step 4: Plug in the front connector

3.5. Installing and removing the coupler

3.5.1. Installation

Place the coupler, together with the attached base module, on the DIN rail by moving it straight towards the rail. Then push the coupler towards the rail until the base module's rail fastener snaps into place with a soft click.

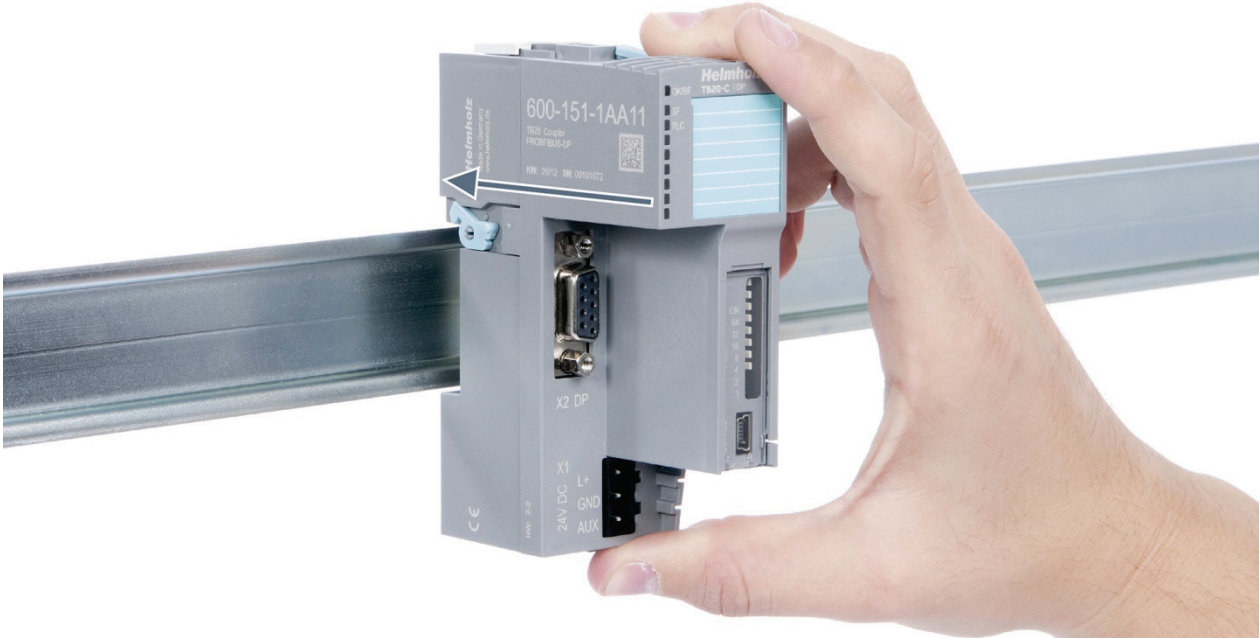

Step 2: Secure the coupler on the DIN rail

Use the locking lever on the left side of the coupler to lock the coupler into position on the DIN rail.

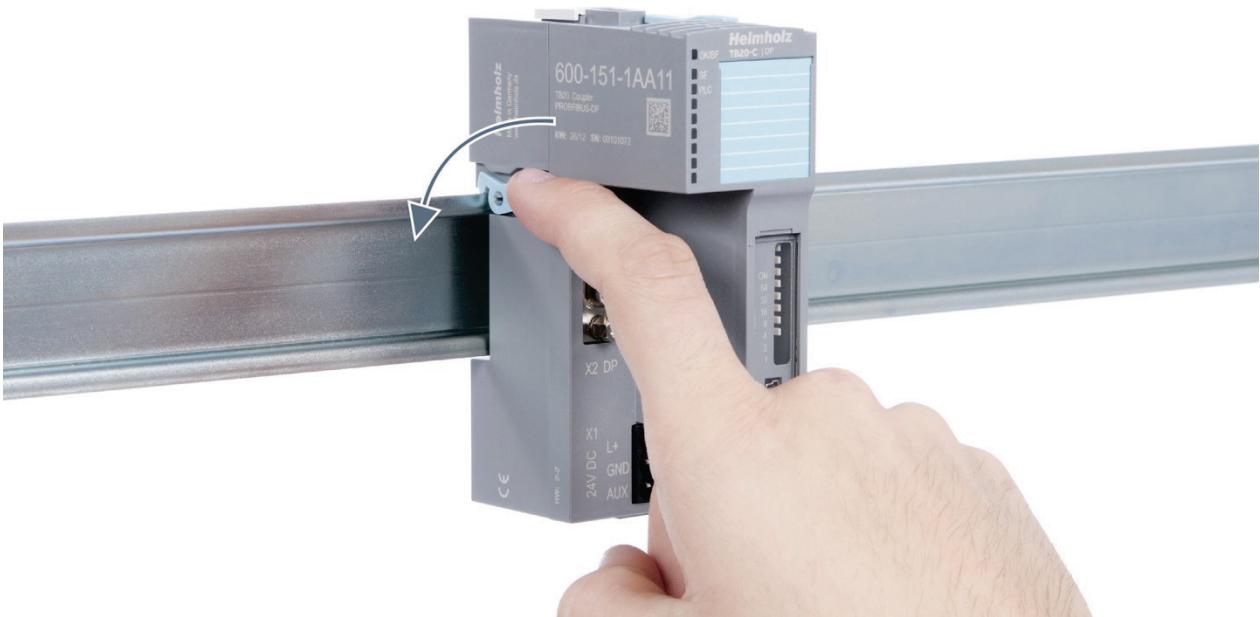

3.5.2. Removal

Step 1: Release the locking mechanism

Release the locking lever on the left side of the coupler in order to disengage it from the DIN rail.

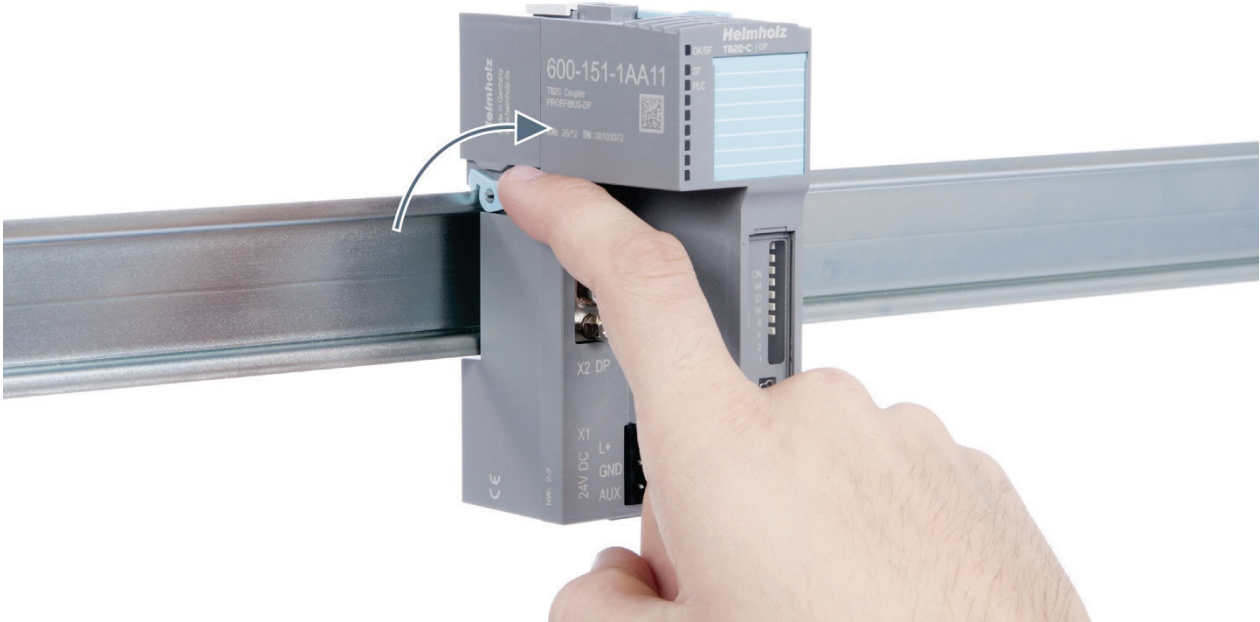

Step 2: Remove the coupler

Use your middle finger to push on the lever from above and use your thumb and index finger to pull out the coupler while holding the lever down.

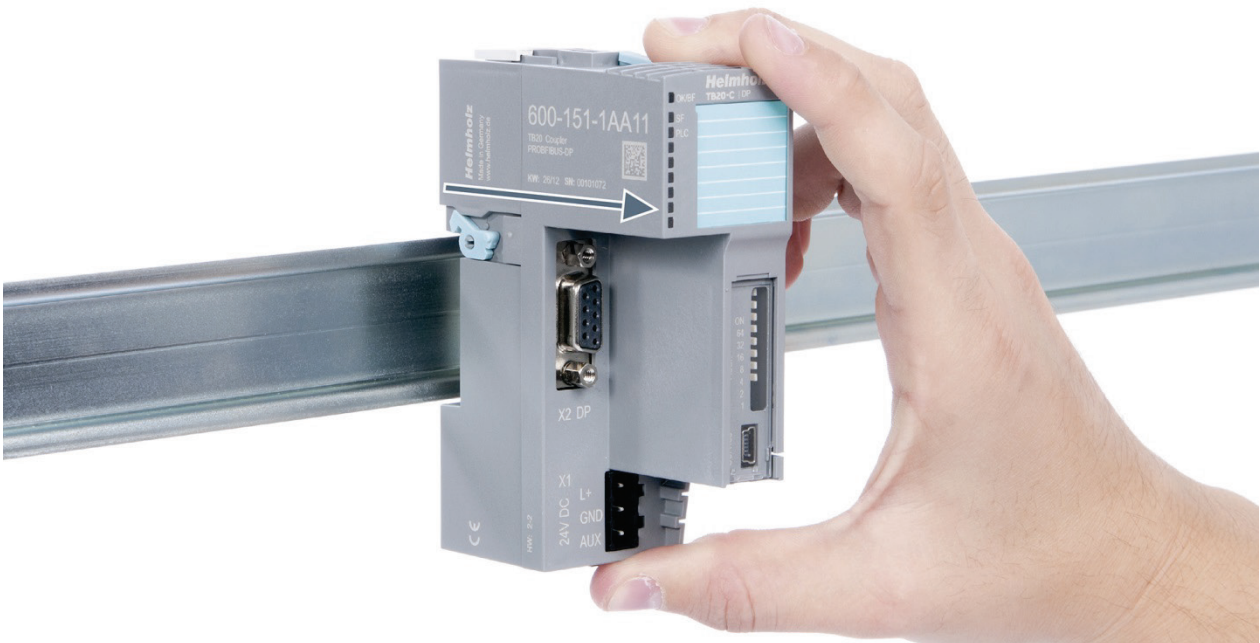

Step 3: Release the base module

Use a screwdriver to release the base module.

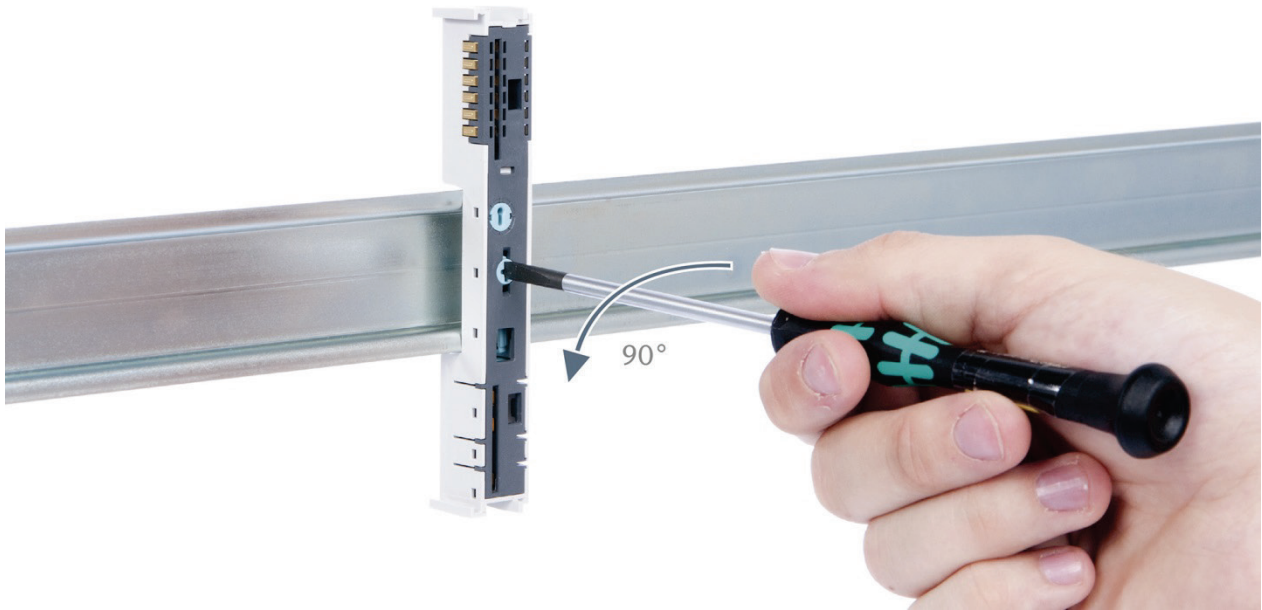

Step 4: Remove the base module

Remove the base module by pulling it towards you.

3.6. Installing and removing the final cover

3.6.1. Installation

Slide the final cover onto the last module along the case, starting from the end with the front connector and moving towards the DIN rail, until the cover covers the base module's contacts and the tab snaps into place.

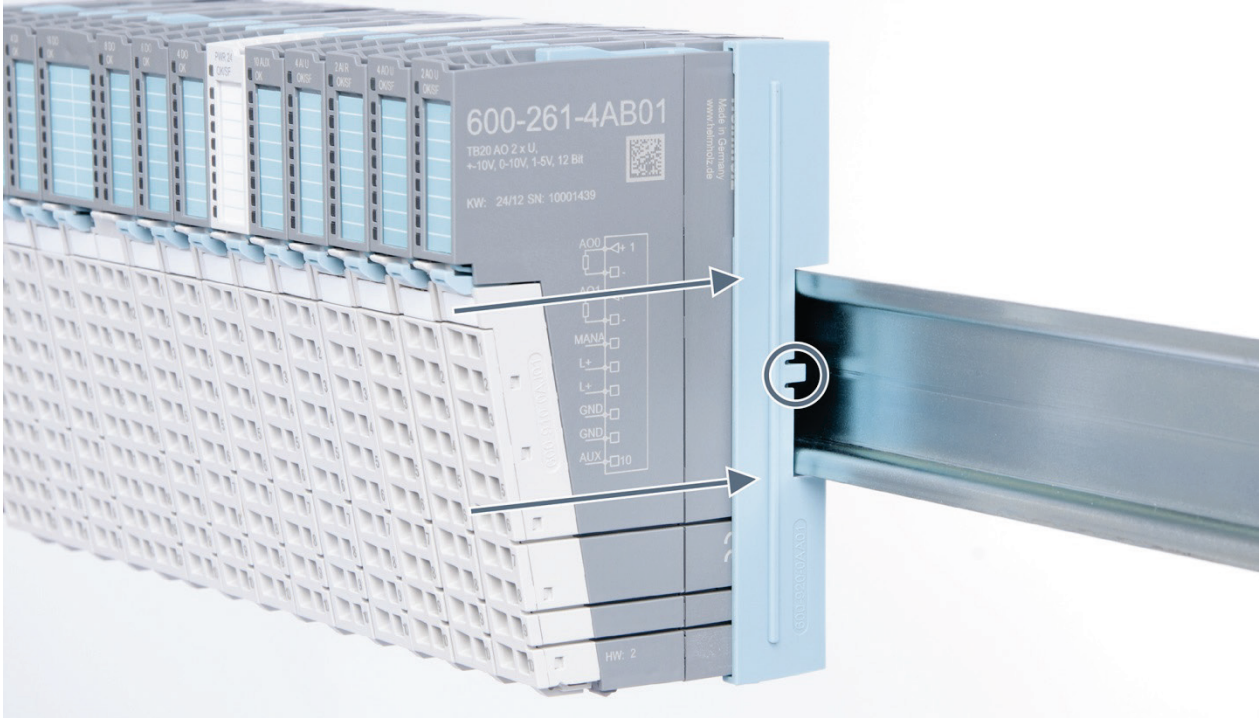

3.6.2. Removal

Pull the final bus cover upward along and off of the module.

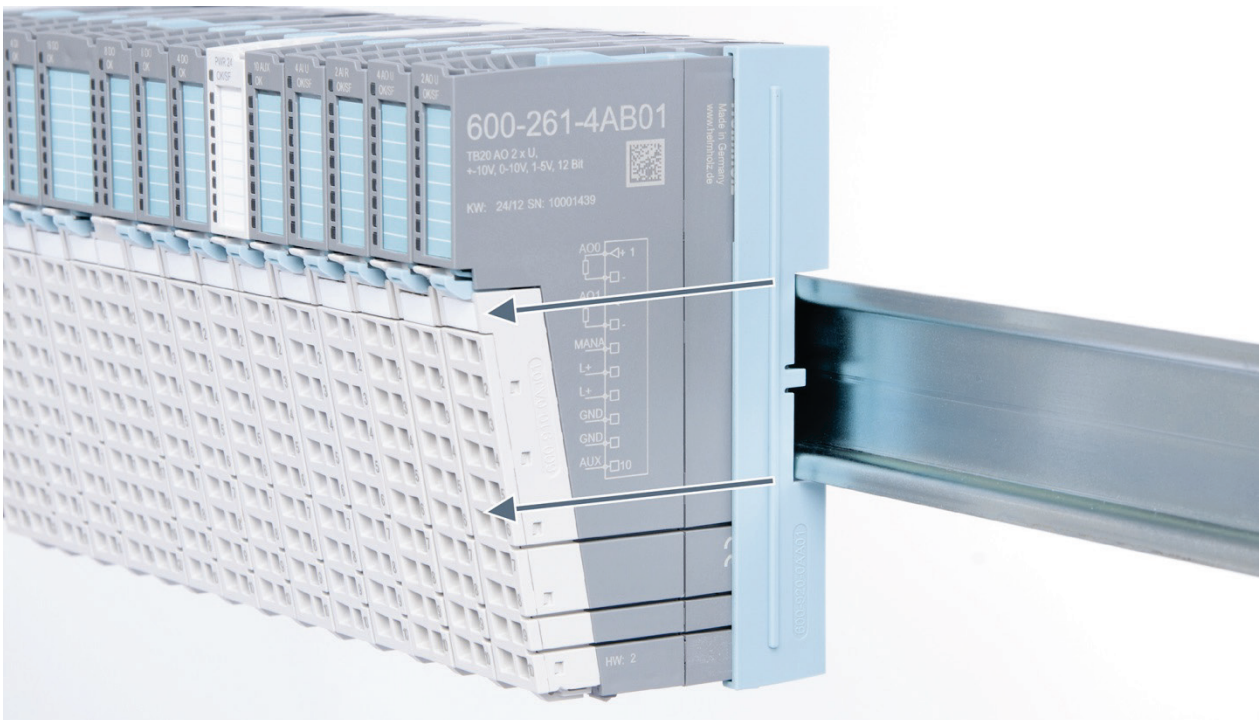

4. Setup and wiring

4.1. EMC/safety/shielding

The TB20 IO system complies with EU Directive 2004/108/EC (“Electromagnetic Compatibility”).

One effective way to protect against disturbances caused by electromagnetic interference is to shield electric cables, wires, and components.



ATTENTION

When setting up the system and laying the necessary cables, make sure to fully comply with all standards, regulations, and rules regarding shielding (please also consult the relevant guidelines and documents published by the PROFIBUS User Organization). All work must be done professionally!

Shielding faults can result in serious malfunctions, including the system’s failure.

To ensure electromagnetic compatibility (EMC) in your control cabinets in electrically harsh environments, the following EMC rules are to be observed in the design and the setup:

- All metal parts of the cabinet are to be connected with each other over a large area with good conductivity (no paint on paint). Where necessary, use contact washers or serrated washers.
- The cabinet door must be connected to the ground straps (top, middle, bottom) over as short a distance as possible.
- Signal cables and power cables are to be laid separated spatially by a minimum distance of 20 cm from each in order to avoid coupling paths.
- Run signal lines only from one level into the cabinet if possible.
- Unshielded cables in the same circuit (outgoing and incoming conductors) must be twisted if possible.
- Contactors, relays, and solenoid valves in the closet, or in adjacent cabinets if applicable, must be provided with quenching combinations; e.g., with RC elements, varistors, diodes.
- Do not lay wires freely in the closet; instead, run them as closely as possible to the cabinet housing or mounting panels. This also applies to reserve cables. These must be grounded on at least one end, and it is better if they are grounded at both ends (additional shielding effect).
- Unnecessary line lengths should be avoided. Coupling capacitances and inductances are kept low in this way.
- Analog signal lines and data lines must be shielded.

4.2. Front connectors

The front connector's spring-clamp terminals are designed for a cross-sectional cable area of up to 1.5 mm² (16–22 AWG) with or without ferrules.

It is also possible, for example, to connect two 0.75 mm² wires to a single spring-type terminal, provided the maximum cross-sectional cable area of 1.5 mm² per terminal is not exceeded.

The cables can be attached to the underside of the front connector with a cable tie.

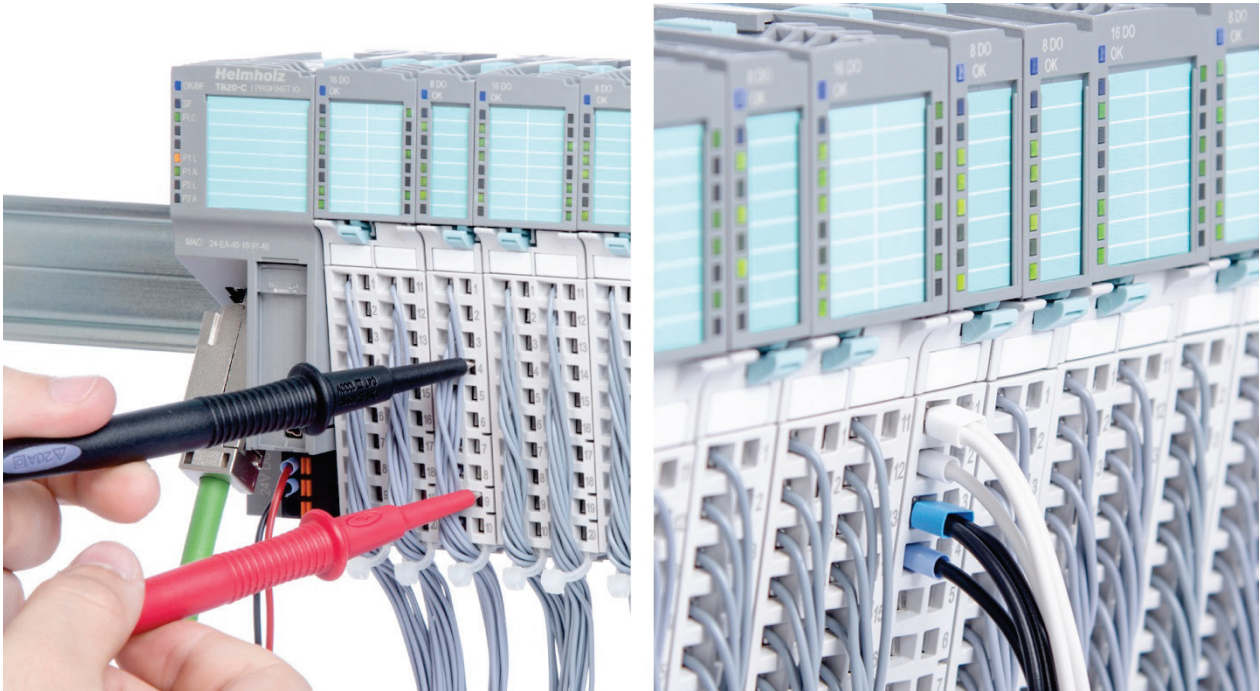

4.3. Wiring the coupler

A power supply unit is integrated into the bus coupler. The power supply unit is responsible for powering the peripheral modules connected to the coupler.

In turn, it draws its own power from the three-pin connector on the front (24 VDC, GND, AUX).

The 24 V connector is used to power two buses:

- The power bus used to power the I/O components (24 VDC, GND, AUX)
- The communications bus used to power the electronics in the peripheral modules

The AUX pin can be used to connect and use an additional voltage potential. Every peripheral module has an AUX terminal on its front connector (the bottommost terminal, i.e., terminals 10 and 20).

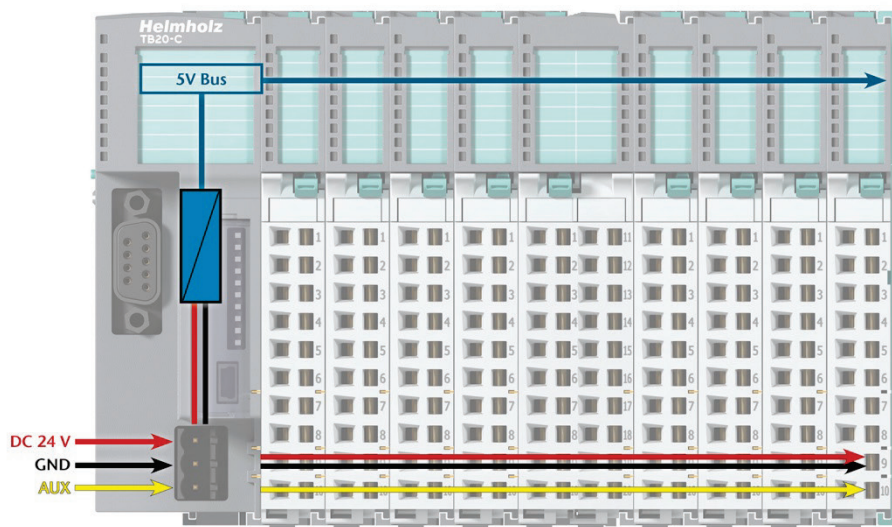

The coupler and the modules are grounded via the shield contact to the DIN rail. The DIN rail must be grounded. The surface of the DIN rail must be clean and conduct electricity well.

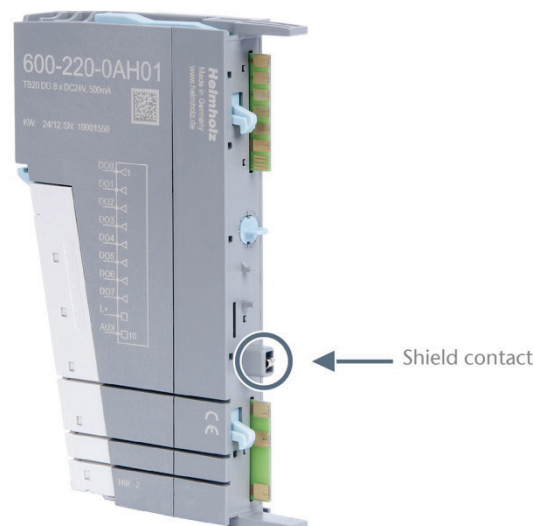

4.4. Using power and isolation modules

Power and isolation modules make it possible to segment the power supply for external signals (24 V, GND, AUX) into individual power supply sections that are powered separately.

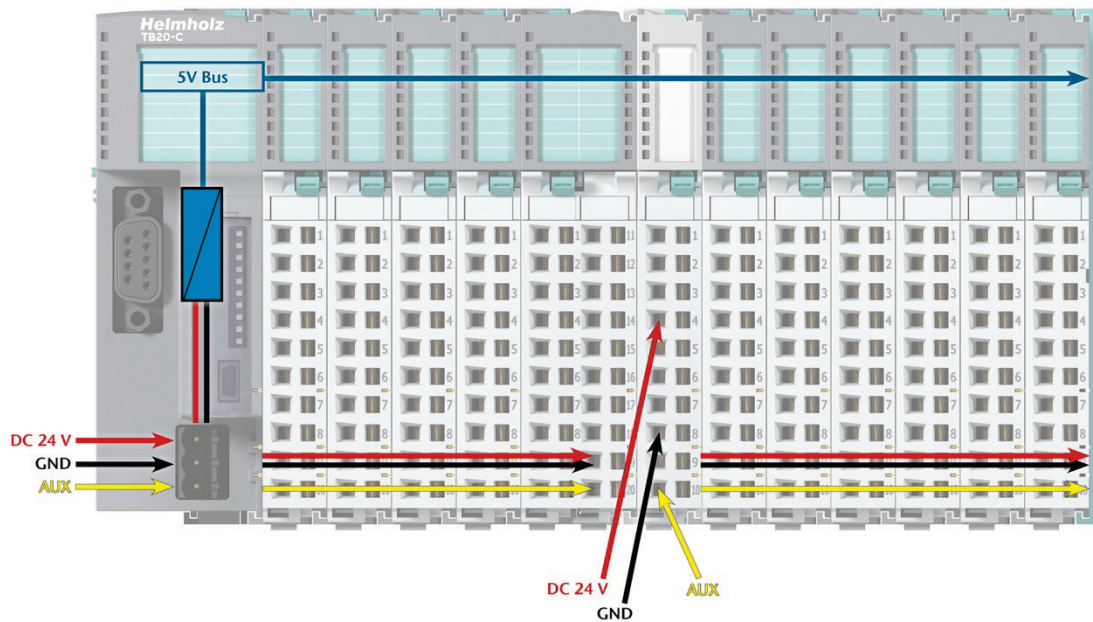

The order no. for the power and isolation module for 24 V signals is 600-710-0AA01.

Its electronic module and base module have the same light gray color as the front connector, ensuring that all power and isolation modules will stand out visually in the system and make it easy to clearly distinguish each individual power supply segment.



4.5. Separate power supply segments for the coupler and the I/O components

If the power supply for the coupler needs to be separate from the power supply for the I/O modules, a power and isolation module can be used right after the coupler.

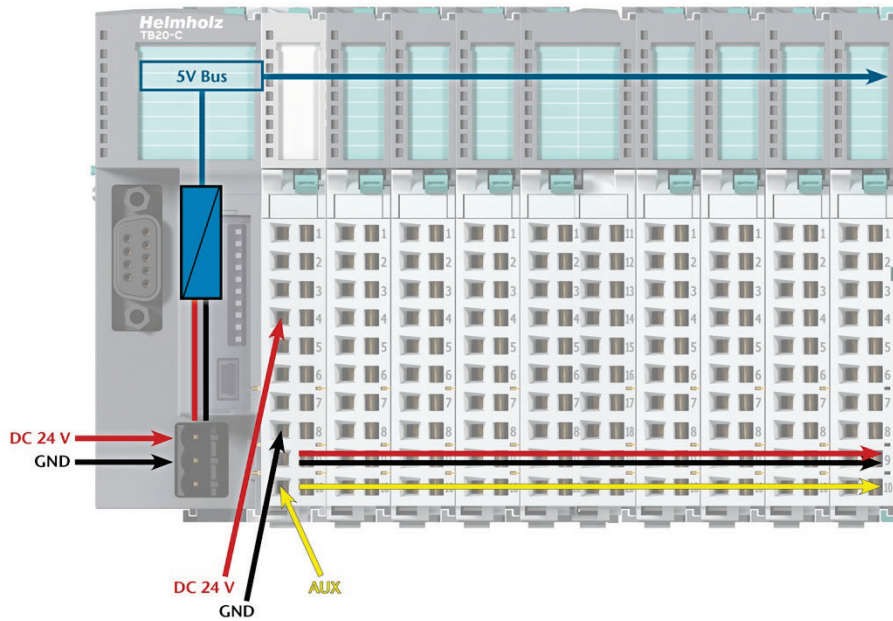

4.6. Using power modules

Power modules deliver all necessary power to the connected peripheral modules and, if applicable, all the way to the next power module or power and isolation module. Power modules must be used whenever the power supplied by the coupler alone is not sufficient, that is, when there are a large number of modules on the bus. The “TB20 ToolBox” parameter configuration and diagnosis program can be used to calculate a system’s total current draw.

24 VDC, GND, and AUX are fed into the terminals on the front, while the connected modules are powered through the base modules’ bus system.

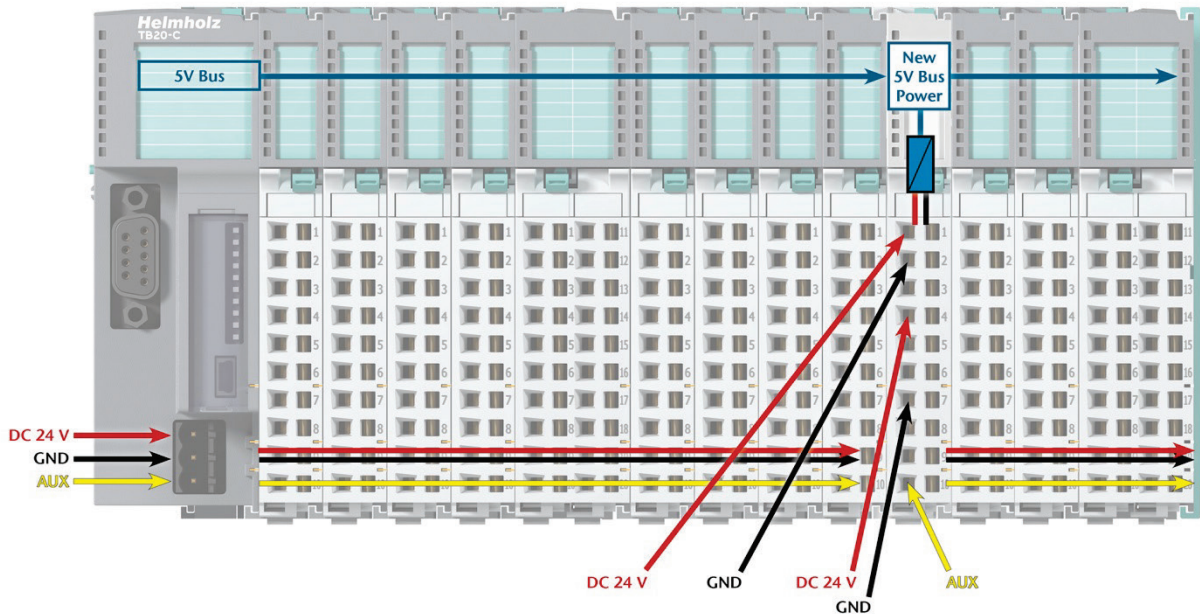

The order no. for the power module is 600-700-0AA01. The electronic module of the power module is light gray like the front connector. The base module of the power module is light gray with a dark top part.



4.7. Function of the LEDs

The topmost OK/SF LED indicates the current system status of each module.

Solid blue light: The module is running (RUN)

Slowly flashing blue light: The module is stopped (STOP); substitute values (if any) are being applied

Quickly flashing blue light: The module is idle (IDLE); its parameters have not been configured yet

Solid red light: The module is indicating a diagnostic error

Flashing red light: The module is indicating a parameter assignment error

The red “SF” LED lights will only be shown on modules with configurable parameters or diagnostic capabilities.

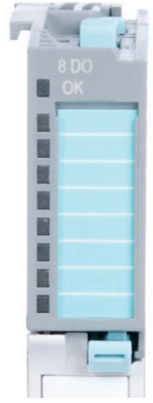

NOTE

IDLE mode (quickly flashing blue LED) indicates modules that have not been added to ongoing system operation by the coupler. One of the reasons that can cause this is an incorrect configuration (wrong module model on the slot).

4.8. Electronic nameplate

All of a TB20 module’s important information can be found on its electronic nameplate. This information includes, for example, the corresponding module ID, module type, order number, unique serial number, hardware version, firmware version, and internal range of functionalities.

This information can be read in a number of ways, one of which is using the “TB20 ToolBox” configuration and diagnosis program. The modules’ electronic nameplates not only make it possible to prevent configuration errors (setup), but also make maintenance (servicing) easier.

4.9. Fusing

The TB20 coupler’s and power modules’ power supply must be externally fused with a slow-blowing fuse, maximum 8 A, appropriate for the required maximum current.

4.10. General technical specifications

Certifications	CE
Noise immunity	DIN EN 61000-6-2 "EMC Immunity"
Interference emission	DIN EN 61000-6-4 "EMC Emission"
Vibration and shock resistance	DIN EN 60068-2-8:2008 "Vibration" DIN EN 60068-2-7:2010 "Shock"
Isolation voltage	1.5 kV
Protection rating	IP 20
Relative humidity	95% without condensation
Installation position	Any
Permissible ambient temperature	0 °C to 60 °C
Transport and storage temperature	-20 °C to 80 °C
Pollution degree	2 (for UL508 certified modules)

5. Digital modules

5.1. Digital Input Modules

5.1.1. 600-210-0AB01, DI 2 x DC 24 V

Characteristics

- 2 inputs, electrically isolated from the backplane bus
- 24 V DC input voltage
- Can accommodate 2-wire proximity sensors
- A blue LED indicates the module's operating status
- Green LEDs (one for each input) indicate the inputs' states

Pin assignment

Connection	I/O
1	Input 0
2	Input 1
3	GND
4	GND
5	L+, 24 VDC
6	L+, 24 VDC
7	AUX
8	AUX
9	L+, 24 VDC
10	AUX

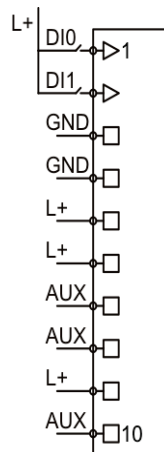

Technical data

Order no.	600-210-0AB01
Name	DI 2 x DC 24 V
Module ID / module type	1200 _{dec.} / 0x0102
Number of inputs	2
Electrically isolated from backplane bus	Yes
Channels electrically isolated from each other	No
Current draw	
External	Max. 0 mA
Internal	Max. 22 mA
Power dissipation	Max. 0.5 W
Input characteristic curve	Type 2, EN 61131-2
Reverse polarity protection for inputs	Yes
Input voltage	
For signal "0"	-3 V to 9 V
For signal "1"	12 V to 30 V
Hot plug-compatible	Yes
Weight	Approx. 70 g
Certification	UL 508

5.1.2. 600-210-0AD01, DI 4 x DC 24 V

Characteristics

- 4 inputs, electrically isolated from the backplane bus
- 24 V DC input voltage
- Can accommodate 2-wire proximity sensors
- A blue LED indicates the module's operating status
- Green LEDs (one for each input) indicate the inputs' states

Pin assignment

Connection	I/O
1	Input 0
2	Input 1
3	Input 2
4	Input 3
5	L+, 24 VDC
6	L+, 24 VDC
7	AUX
8	AUX
9	L+, 24 VDC
10	AUX

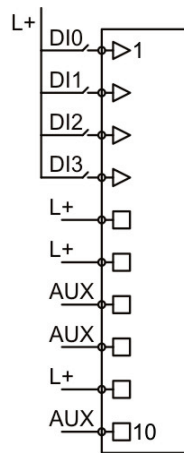

Technical data

Order no.	600-210-0AD01
Name	DI 4 x DC 24 V
Module ID / module type	1400 _{dec.} / 0x0104
Number of inputs	4
Electrically isolated from backplane bus	Yes
Channels electrically isolated from each other	No
Current draw	
External	Max. 0 mA
Internal	Max. 22 mA
Power dissipation	Max. 0.95 W
Input characteristic curve	Type 2, EN 61131-2
Reverse polarity protection for inputs	Yes
Input voltage	
For signal "0"	-3 V to 9 V
For signal "1"	12 V to 30 V
Hot plug-compatible	Yes
Weight	Approx. 70 g
Certification	UL 508

5.1.3. 600-210-0AH01, DI 8 x DC 24 V

Characteristics

- 8 inputs, electrically isolated from the backplane bus
- 24 V DC input voltage
- Can accommodate 2-wire proximity sensors
- A blue LED indicates the module's operating status
- Green LEDs (one for each input) indicate the inputs' states

Pin assignment

Connection	I/O
1	Input 0
2	Input 1
3	Input 2
4	Input 3
5	Input 4
6	Input 5
7	Input 6
8	Input 7
9	L+, 24 VDC
10	AUX

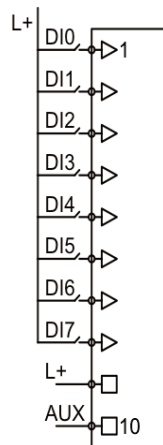

Technical data

Order no.	600-210-0AH01
Name	DI 8 x DC 24 V
Module ID / module type	1800 _{dec.} / 0x0108
Number of inputs	8
Electrically isolated from backplane bus	Yes
Channels electrically isolated from each other	No
Current draw	
External	Max. 0 mA
Internal	Max. 22 mA
Power dissipation	Max. 1.85 W
Input characteristic curve	Type 2, EN 61131-2
Reverse polarity protection for inputs	Yes
Input voltage	
For signal "0"	-3 V to 9 V
For signal "1"	12 V to 30 V
Hot plug-compatible	Yes
Weight	Approx. 70 g
Certification	UL 508

5.1.4. 600-210-0AP21, DI 16 x DC 24 V

Characteristics

- 16 inputs, electrically isolated from the backplane bus
- 24 V DC input voltage
- Can accommodate 2-wire proximity sensors
- A blue LED indicates the module's operating status
- Green LEDs (one for each input) indicate the inputs' states

Pin assignment

Connection	I/O	Connection	I/O
1	Input 0	11	Input 8
2	Input 1	12	Input 9
3	Input 2	13	Input 10
4	Input 3	14	Input 11
5	Input 4	15	Input 12
6	Input 5	16	Input 13
7	Input 6	17	Input 14
8	Input 7	18	Input 15
9	L+, 24 VDC	19	L+, 24 VDC
10	AUX	20	AUX

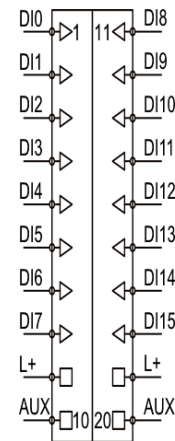

Technical data

Order no.	600-210-0AP21
Name	DI 16 x DC 24 V
Module ID / module type	1900 _{dec.} / 0x0109
Number of inputs	16
Electrically isolated from backplane bus	Yes
Channels electrically isolated from each other	No
Current draw	
External	Max. 0 mA
Internal	Max. 23 mA
Power dissipation	Max. 3.7 W
Input characteristic curve	Type 2, EN 61131-2
Reverse polarity protection for inputs	Yes
Input voltage	
For signal "0"	-3 V to 9 V
For signal "1"	12 V to 30 V
Hot plug-compatible	Yes
Weight	Approx. 110 g
Certification	UL 508

5.1.5. 600-210-0DH01, DI 8 x 24 V GND reading

Characteristics

- 8 inputs, electrically isolated from the backplane bus
- A blue LED indicates the module's operating status
- Green LEDs (one for each input) indicate the inputs' states

Pin assignment

Connection	I/O
1	Input 0
2	Input 1
3	Input 2
4	Input 3
5	Input 4
6	Input 5
7	Input 6
8	Input 7
9	L+, 24 VDC
10	AUX

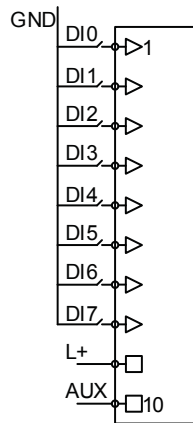

Technical data

Order no.	600-210-0DH01
Name	DI 8 x 24 V GND reading
Module ID / module type	1801 _{dec.} / 0x0108
Number of inputs	8
Electrically isolated from backplane bus	Yes
Channels electrically isolated from each other	No
Current draw	
External	Max. 0 mA
Internal	Max. 22 mA
Power dissipation	Max. 1.85 W
Input characteristic curve	Type 3, EN 61131-2
Reverse polarity protection for inputs	Yes
Input voltage	
For signal "0"	Vcc -5 .. Vcc
For signal "1"	0 V ... Vcc-11 V
Hot plug-compatible	Yes
Weight	Approx. 70 g
Certification	UL 508

5.1.6. 600-210-0DP21, DI 16 x 24 V GND reading

Characteristics

- 16 inputs, electrically isolated from the backplane bus
- A blue LED indicates the module's operating status
- Green LEDs (one for each input) indicate the inputs' states

Pin assignment

Connection	I/O	Connection	I/O
1	Input 0	11	Input 8
2	Input 1	12	Input 9
3	Input 2	13	Input 10
4	Input 3	14	Input 11
5	Input 4	15	Input 12
6	Input 5	16	Input 13
7	Input 6	17	Input 14
8	Input 7	18	Input 15
9	L+, 24 VDC	19	L+, 24 VDC
10	AUX	20	AUX

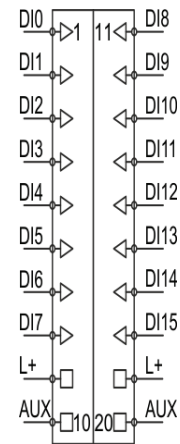

Technical data

Order no.	600-210-0DP21
Name	DI 16 x 24 V GND reading
Module ID / module type	1901 _{dec.} / 0x0109
Number of inputs	16
Electrically isolated from backplane bus	Yes
Channels electrically isolated from each other	No
Current draw	
External	Max. 0 mA
Internal	Max. 23 mA
Power dissipation	Max. 3.7 W
Input characteristic curve	Type 2, EN 61131-2
Reverse polarity protection for inputs	Yes
Input voltage	
For signal "0"	Vcc -5 .. Vcc
For signal "1"	0 V ... Vcc-11 V
Hot plug-compatible	Yes
Weight	Approx. 110 g
Certification	UL 508

5.1.7. 600-210-0CC01, DI 3 x DC 24 V, 3-wire

Characteristics

- 3 inputs, electrically isolated from the backplane bus
- 24 V DC input voltage
- Can accommodate 3-wire sensors
- Fuse for 24 VDC
- A blue LED indicates the module's operating status
- Green LEDs (one for each input) indicate the inputs' states

Pin assignment

Connection	I/O
1	Input 0
2	L+, 24 VDC
3	GND
4	Input 1
5	L+, 24 VDC
6	GND
7	Input 2
8	L+, 24 VDC
9	GND
10	AUX

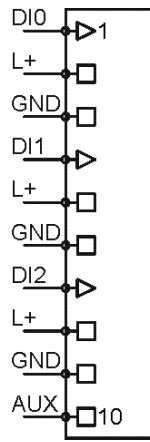

Technical data

Order no.	600-210-0CC01
Name	DI 3 x DC 24 V, 3-wire
Module ID / module type	1300 _{dec.} / 0x0103
Number of inputs	3
Electrically isolated from backplane bus	Yes
Channels electrically isolated from each other	No
Current draw	
External	Max. 0 mA
Internal	Max. 22 mA
Power dissipation	Max. 0.7 W
Input characteristic curve	Type 2, EN 61131-2
Reverse polarity protection for inputs	Yes
Input voltage	
For signal "0"	-3 V to 9 V
For signal "1"	12 V to 30 V
L+ fuse	4 A per group. Group 1: Terminals 2, 5, & 8;
Weight	Approx. 70 g
Certification	UL 508

5.1.8. 600-210-0CF21, DI 6 x DC 24 V, 3-wire

Characteristics

- 6 inputs, electrically isolated from the backplane bus
- 24 V DC input voltage
- Can accommodate 3-wire sensors
- Fuse for 24 VDC
- A blue LED indicates the module's operating status
- Green LEDs (one for each input) indicate the inputs' states

Pin assignment

Connection	I/O	Connection	I/O
1	Input 0	11	Input 3
2	L+, 24 VDC	12	L+, 24 VDC
3	GND	13	GND
4	Input 1	14	Input 4
5	L+, 24 VDC	15	L+, 24 VDC
6	GND	16	GND
7	Input 2	17	Input 5
8	L+, 24 VDC	18	L+, 24 VDC
9	GND	19	GND
10	AUX	20	AUX

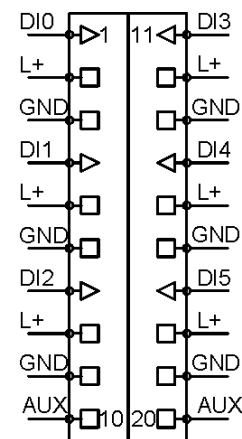

Technical data

Order no.	600-210-0CF21
Name	DI 6 x DC 24 V, 3-wire
Module ID / module type	1600 _{dec.} / 0x0106
Number of inputs	6
Electrically isolated from backplane bus	Yes
Channels electrically isolated from each other	No
Current draw	
External	Max. 0 mA
Internal	Max. 22 mA
Power dissipation	Max. 1.4 W
Input characteristic curve	Type 2, EN 61131-2
Reverse polarity protection for inputs	Yes
Input voltage	
For signal "0"	-3 V to 9 V
For signal "1"	12 V to 30 V
L+ fuse	4 A per group, group 1: terminals 2, 5, & 8 group 2: terminals 12, 15, and 18
Weight	Approx. 110 g
Certification	UL 508

5.1.9. 600-211-0BB01, DI 2 x AC 230 V, per channel N

Characteristics

- 2 inputs, electrically isolated from the backplane bus
- 110 – 230 V AC input voltage
- Each channel has its own individual neutral conductor terminal
- A blue LED indicates the module's operating status
- Green LEDs (one for each input) indicate the inputs' states

Pin assignment

Connection	I/O
1	Input 0 L
2	Input 0 N
3	Input 1 L
4	Input 1 N
5	n.c.
6	n.c.
7	n.c.
8	n.c.
9	n.c.
10	AUX

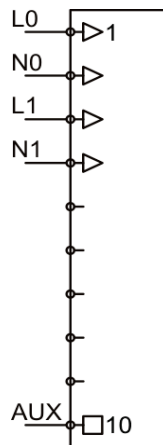

Technical data

Order no.	600-211-0BB01
Name	DI 2 x AC 230 V, per channel N
Module ID / module type	1221 _{dec.} / 0x0102
Number of inputs	2
Electrically isolated from backplane bus	Yes
Channels electrically isolated from each other	Yes
Current draw	
External	Max. 0 mA
Internal	Max. 22 mA
Power dissipation	Max. 3.8 W
Input characteristic curve	Type 1, EN 61131-2
Input frequency	50 Hz / 60 Hz
Input voltage	
For signal "0"	0 V to 40 V
For signal "1"	79 V to 253 V
Weight	Approx. 70 g
Certification	UL 508

5.1.10. 600-211-0BD01, DI 4 x AC 230 V, per channel N

Characteristics

- 4 inputs, electrically isolated from the backplane bus
- 110 – 230 V AC input voltage
- Each channel has its own individual neutral conductor terminal
- A blue LED indicates the module's operating status
- Green LEDs (one for each input) indicate the inputs' states

Pin assignment

Connection	I/O
1	Input 0 L
2	Input 0 N
3	Input 1 L
4	Input 1 N
5	Input 2 L
6	Input 2 N
7	Input 3 L
8	Input 3 N
9	n.c.
10	AUX

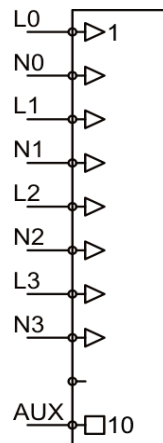

Technical data

Order no.	600-211-0BD01
Name	DI 4 x AC 230 V, per channel N
Module ID / module type	1421 _{dec.} / 0x0104
Number of inputs	4
Electrically isolated from backplane bus	Yes
Channels electrically isolated from each other	Yes
Current draw	
External	Max. 0 mA
Internal	Max. 22 mA
Power dissipation	Max. 7.6 W
Input characteristic curve	Type 1, EN 61131-2
Input frequency	50 Hz / 60 Hz
Input voltage	
For signal "0"	0 V to 40 V
For signal "1"	79 V to 253 V
Weight	Approx. 70 g
Certification	UL 508

5.1.11. 600-211-0BH21, DI 8 x AC 230 V, per channel N

Characteristics

- 8 inputs, electrically isolated from the backplane bus
- 110 – 230 V AC input voltage
- Each channel has its own individual neutral conductor terminal
- A blue LED indicates the module's operating status
- Green LEDs (one for each input) indicate the inputs' states

Pin assignment

Connection	I/O	Connection	I/O
1	Input 0 L	11	Input 4 L
2	Input 0 N	12	Input 4 N
3	Input 1 L	13	Input 5 L
4	Input 1 N	14	Input 5 N
5	Input 2 L	15	Input 6 L
6	Input 2 N	16	Input 6 N
7	Input 3 L	17	Input 7 L
8	Input 3 N	18	Input 7 N
9		19	
10	AUX	20	AUX

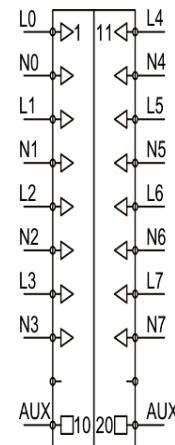

Technical data

Order no.	600-211-0BH21
Name	DI 8 x AC 230 V, per channel N
Module ID / module type	1821 _{dec.} / 0x0108
Number of inputs	8
Electrically isolated from backplane bus	Yes
Channels electrically isolated from each other	Yes
Current draw	
External	Max. 0 mA
Internal	Max. 22 mA
Power dissipation	Max. 15.2 W
Input characteristic curve	Type 1, EN 61131-2
Input frequency	50 Hz / 60 Hz
Input voltage	
For signal "0"	0 V to 40 V
For signal "1"	79 V to 253 V
Weight	Approx. 110 g
Certification	UL 508

5.2. Digital output modules

5.2.1. 600-220-0AB01, DO 2 x DC 24 V, 500 mA

Characteristics

- 2 outputs, electrically isolated from the backplane bus
- 24 V DC output voltage
- 500 mA output voltage per channel
- A blue LED indicates the module's operating status
- Green LEDs (one for each output) indicate the outputs' states

Pin assignment

Connection	I/O
1	Output 0
2	Output 1
3	GND
4	GND
5	L+, 24 VDC
6	L+, 24 VDC
7	AUX
8	AUX
9	L+, 24 VDC
10	AUX

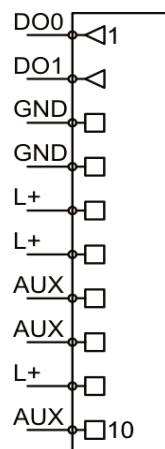

Technical data

Order no.	600-220-0AB01
Name	DO 2 x DC 24 V, 500 mA
Module ID / module type	2200 _{dec.} / 0x0120
Number of outputs	2
Electrically isolated from backplane bus	Yes
Channels electrically isolated from each other	No
Supply voltage U_p, U_s	
Rated	24 V DC
Ripple U_{ss}	Max. 3.6 V
Permissible range (with ripple)	20 ... 30 V
Voltage for $t < 10$ ms	50 V
Output current	
Rated	500 mA
Leakage current	Max. 0.5 mA
Current draw	
External	Max. 10 mA + load
Internal	Max. 27.5 mA
Power dissipation	Max. 0.7 W
Output short-circuit protection	Electronic, for each individual channel
Inductive cutoff voltage limit	-48 V
Weight	Approx. 70 g
Certification	UL 508

5.2.2. 600-220-0AD01, DO 4 x DC 24 V, 500 mA

Characteristics

- 4 outputs, electrically isolated from the backplane bus
- 24 V DC output voltage
- 500 mA output voltage per channel
- A blue LED indicates the module's operating status
- Green LEDs (one for each output) indicate the outputs' states

Pin assignment

Connection	I/O
1	Output 0
2	Output 1
3	Output 2
4	Output 3
5	L+, 24 VDC
6	L+, 24 VDC
7	AUX
8	AUX
9	L+, 24 VDC
10	AUX

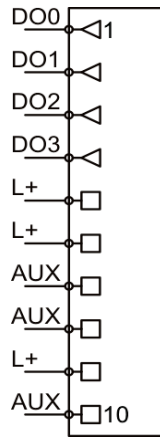

Technical data

Order no.	600-220-0AD01
Name	DO 4 x DC 24 V, 500 mA
Module ID / module type	2400 _{dec.} / 0x0140
Number of outputs	4
Electrically isolated from backplane bus	Yes
Channels electrically isolated from each other	No
Supply voltage U_p , U_s	
Rated	24 V DC
Ripple U_{ss}	Max. 3.6 V
Permissible range (with ripple)	20 ... 30 V
Voltage for $t < 10$ ms	50 V
Output current	
Rated	500 mA
Leakage current	Max. 0.5 mA
Current draw	
External	Max. 20 mA + load
Internal	Max. 30 mA
Power dissipation	Max. 1.0 W
Output short-circuit protection	Electronic, for each individual channel
Inductive cutoff voltage limit	-48 V
Weight	Approx. 70 g
Certification	UL 508

5.2.3. 600-220-0AH01, DO 8 x DC 24 V, 500 mA

Characteristics

- 8 outputs, electrically isolated from the backplane bus
- 24 V DC output voltage
- 500 mA output voltage per channel
- A blue LED indicates the module's operating status
- Green LEDs (one for each output) indicate the outputs' states

Pin assignment

Connection	I/O
1	Output 0
2	Output 1
3	Output 2
4	Output 3
5	Output 4
6	Output 5
7	Output 6
8	Output 7
9	L+, 24 VDC
10	AUX

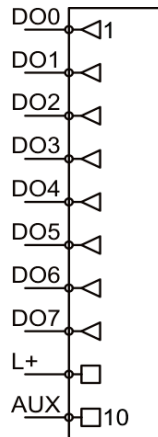

Technical data

Order no.	600-220-0AH01
Name	DO 8 x DC 24 V, 500 mA
Module ID / module type	2800 _{dec.} / 0x0180
Number of outputs	8
Electrically isolated from backplane bus	Yes
Channels electrically isolated from each other	No
Supply voltage U_p , U_s	
Rated	24 V DC
Ripple U_{ss}	Max. 3.6 V
Permissible range (with ripple)	20 ... 30 V
Voltage for $t < 10$ ms	50 V
Output current	
Rated	500 mA
Leakage current	Max. 0.5 mA
Current draw	
External	Max. 40 mA + load
Internal	Max. 35 mA
Power dissipation	Max. 2.5 W
Output short-circuit protection	Electronic, for each individual channel
Inductive cutoff voltage limit	-48 V
Weight	Approx. 70 g
Certification	UL 508

5.2.4. 600-220-0AP21, DO 16 x DC 24 V, 500 mA

Characteristics

- 16 outputs, electrically isolated from the backplane bus
- 24 V DC output voltage
- 500 mA output voltage per channel
- A blue LED indicates the module's operating status
- Green LEDs (one for each output) indicate the outputs' states

Pin assignment

Connection	I/O	Connection	I/O
1	Output 0	11	Output 8
2	Output 1	12	Output 9
3	Output 2	13	Output 10
4	Output 3	14	Output 11
5	Output 4	15	Output 12
6	Output 5	16	Output 13
7	Output 6	17	Output 14
8	Output 7	18	Output 15
9	L+, 24 VDC	19	L+, 24 VDC
10	AUX	20	AUX

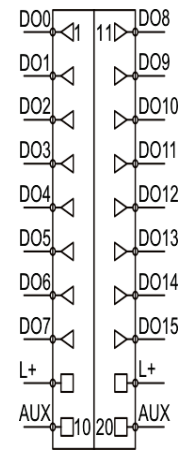

Technical data

Order no.	600-220-0AP21
Name	DO 16 x DC 24 V, 500 mA
Module ID / module type	2900 _{dec.} / 0x0190
Number of outputs	16
Electrically isolated from backplane bus	Yes
Channels electrically isolated from each other	No
Supply voltage U_p, U_s	
Rated	24 V DC
Ripple U_{ss}	Max. 3.6 V
Permissible range (with ripple)	20 ... 30 V
Voltage for $t < 10$ ms	50 V
Output current	
Rated	500 mA
Leakage current	Max. 0.5 mA
Current draw	
External	Max. 80 mA + load
Internal	Max. 47 mA
Power dissipation	Max. 2.5 W
Output short-circuit protection	Electronic, for each individual channel
Inductive cutoff voltage limit	-48 V
Weight	Approx. 110 g
Certification	UL 508

5.2.5. 600-220-0DH01, DO 8 x DC 24 V, 300 mA, sink

Characteristics

- 8 outputs, electrically isolated from the backplane bus
- 300 mA output voltage per channel
- A blue LED indicates the module's operating status
- Green LEDs (one for each output) indicate the outputs' states

Pin assignment

Connection	I/O
1	Output 0
2	Output 1
3	Output 2
4	Output 3
5	Output 4
6	Output 5
7	Output 6
8	Output 7
9	L+, 24 VDC
10	AUX

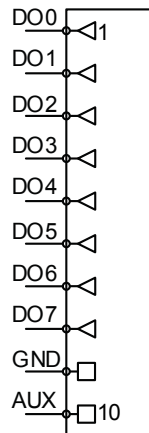

Technical data

Order no.	600-220-0DH01
Name	DO 8 x DC 24 V, 300 mA, sink
Module ID / module type	2801 _{dec.} / 0x0180
Number of outputs	8
Electrically isolated from backplane bus	Yes
Channels electrically isolated from each other	No
Supply voltage U_p , U_s	
Rated	-24 V DC
Ripple U_{ss}	Max. 3.6 V
Permissible range (with ripple)	20 ... 30 V
Voltage for $t < 10$ ms	50 V
Output current	
Rated	300 mA
Leakage current	Max. 0.5 mA
Current draw	
External	Max. 40 mA + load
Internal	Max. 35 mA
Power dissipation	Max. 2.5 W
Output short-circuit protection	Electronic, for each individual channel
Inductive cutoff voltage limit	-48 V
Weight	Approx. 70 g

5.2.6. 600-220-0DP21, DO 16 x DC 24 V, 300 mA, sink

Characteristics

- 16 outputs, electrically isolated from the backplane bus
- 24 V DC output voltage
- 500 mA output voltage per channel
- A blue LED indicates the module's operating status
- Green LEDs (one for each output) indicate the outputs' states

Pin assignment

Connection	I/O	Connection	I/O
1	Output 0	11	Output 8
2	Output 1	12	Output 9
3	Output 2	13	Output 10
4	Output 3	14	Output 11
5	Output 4	15	Output 12
6	Output 5	16	Output 13
7	Output 6	17	Output 14
8	Output 7	18	Output 15
9	L+, 24 VDC	19	L+, 24 VDC
10	AUX	20	AUX

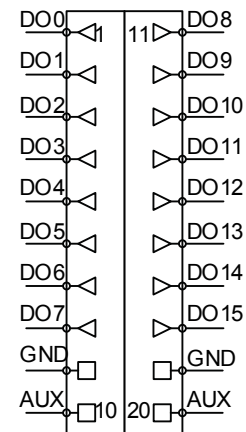

Technical data

Order no.	600-220-0DP21
Name	DO 16 x DC 24 V, 300 mA, sink
Module ID / module type	2901 _{dec.} / 0x0190
Number of outputs	16
Electrically isolated from backplane bus	Yes
Channels electrically isolated from each other	No
Supply voltage U_p, U_s	
Rated	-24 V DC
Ripple U_{ss}	Max. 3.6 V
Permissible range (with ripple)	20 ... 30 V
Voltage for $t < 10$ ms	50 V
Output current	
Rated	300 mA
Leakage current	Max. 0.5 mA
Current draw	
External	Max. 80 mA + load
Internal	Max. 47 mA
Power dissipation	Max. 2.5 W
Output short-circuit protection	Electronic, for each individual channel
Inductive cutoff voltage limit	-48 V
Weight	Approx. 110 g

5.2.7. 600-220-7AD01, DO 4 x DC 24 V, 700 mA, High Feature

Characteristics

- 4 outputs, electrically isolated from the backplane bus
- 24 V DC output voltage
- 700 mA output voltage per channel
- A blue LED indicates the module's operating status
- Green/red LEDs indicate the outputs' states
- 24 V load voltage monitoring and diagnosis
- Short circuit to GND monitoring and diagnosis for each individual channel
- Channel status information in input image table

Pin assignment

Connection	I/O
1	Output 0
2	Output 1
3	Output 2
4	Output 3
5	GND
6	GND
7	GND
8	GND
9	L+, 24 VDC
10	AUX

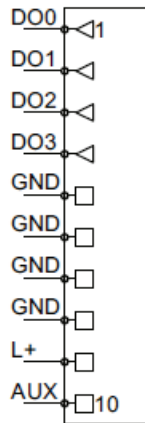

Channel LED signals

Off = Output off

Solid green light = Output on

Solid red light = 24 V load voltage (L+) missing

Flashing red light = Short circuit to GND detected

Output area (1 byte)

	7	6	5	4	3	2	1	0
Byte 0	-	-	-	-	DO 3	DO 2	DO 1	DO 0

Input area (1 byte)

	7	6	5	4	3	2	1	0
Byte 0	Status DO 3		Status DO 2		Status DO 1		Status DO 0	

Status DO: 00 = OK / 01 = short circuit to GND / 10 = 24 V load voltage (L+) missing

Parameters for the module

Diagnostic alarm: ON / OFF

Parameters for each channel

Behavior at CPU-STOP: Output Off / Output On / Keep last value

Pulse lengthening (0 - 255 in 5ms increments)

Technical data

Order no.	600-220-7AD01
Name	DO 4 x DC 24 V, 700 mA, High Feature
Module ID / module type	2410 _{dec.} / 0x1140
Number of outputs	4
Electrically isolated from backplane bus	Yes
Channels electrically isolated from each other	No
Supply voltage U_p , U_s	
Rated	24 V DC
Ripple U_{ss}	Max. 3.6 V
Permissible range (with ripple)	20 ... 30 V
Voltage for $t < 10$ ms	50 V
Output current	
Rated	700 mA
Leakage current	Max. 0.5 mA
Current draw	
External	Max. 20 mA + load
Internal	Max. 30 mA
Power dissipation	Max. 1.0 W
Diagnoses	No external reference voltage (load voltage L+) Short circuit to GND Parameter assignment error
Output short-circuit protection	Electronic, for each individual channel
Inductive cutoff voltage limit	-48 V
Weight	Approx. 70 g
Certification	UL 508

5.2.8. 600-220-7AH01, DO 8 x DC 24 V, 700 mA, High Feature

Characteristics

- 8 outputs, electrically isolated from the backplane bus
- 24 V DC output voltage
- 700 mA output voltage per channel
- A blue LED indicates the module's operating status
- Green/red LEDs indicate the outputs' states
- 24 V load voltage monitoring and diagnosis
- Short circuit to GND monitoring and diagnosis for each individual channel
- Channel status information in input image table

Pin assignment

Connection	I/O
1	Output 0
2	Output 1
3	Output 2
4	Output 3
5	Output 4
6	Output 5
7	Output 6
8	Output 7
9	L+, 24 VDC
10	AUX

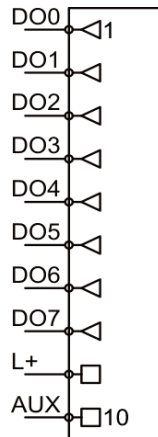

Channel LED signals

Off = Output off

Solid green light = Output on

Solid red light = 24 V load voltage (L+) missing

Flashing red light = Short circuit to GND detected

Output area (1 byte)

	7	6	5	4	3	2	1	0
Byte 0	DO 7	DO 6	DO 5	DO 4	DO 3	DO 2	DO 1	DO 0

Input area (2 bytes)

	7	6	5	4	3	2	1	0
Byte 0	Status DO 3		Status DO 2		Status DO 1		Status DO 0	
Byte 1	Status DO 7		Status DO 6		Status DO 5		Status DO 4	

Status DO: 00 = OK / 01 = short circuit to GND / 10 = 24 V load voltage (L+) missing

Parameters for the module

Diagnostic alarm: ON / OFF

Parameters for each channel

Behavior at CPU-STOP: Output Off / Output On / Keep last value

Pulse lengthening (0 - 255 in 5ms increments)

Technical data

Order no.	600-220-7AH01
Name	DO 8 x DC 24 V, 700 mA, High Feature
Module ID / module type	2810 _{dec.} / 0x1180
Number of outputs	8
Electrically isolated from backplane bus	Yes
Channels electrically isolated from each other	No
Supply voltage U_p , U_s	
Rated	24 V DC
Ripple U_{ss}	Max. 3.6 V
Permissible range (with ripple)	20 ... 30 V
Voltage for $t < 10$ ms	50 V
Output current	
Rated	700 mA
Leakage current	Max. 0.5 mA
Current draw	
External	Max. 40 mA + load
Internal	Max. 35 mA
Power dissipation	Max. 2.5 W
Diagnoses	No external reference voltage (load voltage L+) Short circuit to GND Parameter assignment error
Output short-circuit protection	Electronic, for each individual channel
Inductive cutoff voltage limit	-48 V
Weight	Approx. 70 g
Certification	UL 508

5.2.9. 600-220-7AP21, DO 16 x DC 24 V, 700 mA, High Feature

Characteristics

- 16 outputs, electrically isolated from the backplane bus
- 24 V DC output voltage
- 700 mA output voltage per channel
- A blue LED indicates the module's operating status
- Green/red LEDs indicate the outputs' states
- 24 V load voltage monitoring and diagnosis
- Short circuit to GND monitoring and diagnosis for each individual channel
- Channel status information in input image table

Pin assignment

Connection	I/O	Connection	I/O
1	Output 0	11	Output 8
2	Output 1	12	Output 9
3	Output 2	13	Output 10
4	Output 3	14	Output 11
5	Output 4	15	Output 12
6	Output 5	16	Output 13
7	Output 6	17	Output 14
8	Output 7	18	Output 15
9	L+, 24 VDC	19	L+, 24 VDC
10	AUX	20	AUX

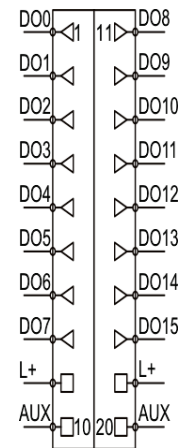

Channel LED signals

Off = Output off

Solid green light = Output on

Solid red light = 24 V load voltage (L+) missing

Flashing red light = Short circuit to GND detected

Parameters for the module

Diagnostic alarm: ON / OFF

Parameters for each channel

Behavior at CPU-STOP: Output Off / Output On / Keep last value

Pulse lengthening (0 - 255 in 5ms increments)

Output area (2 byte)

	7	6	5	4	3	2	1	0
Byte 0	DO 7	DO 6	DO 5	DO 4	DO 3	DO 2	DO 1	DO 0
Byte 1	DO 15	DO 14	DO 13	DO 12	DO 11	DO 10	DO 9	DO 8

Input area (4 bytes)

	7	6	5	4	3	2	1	0
Byte 0	Status DO 3		Status DO 2		Status DO 1		Status DO 0	
Byte 1	Status DO 7		Status DO 6		Status DO 5		Status DO 4	
Byte 2	Status DO 11		Status DO 10		Status DO 9		Status DO 8	
Byte 3	Status DO 15		Status DO 14		Status DO 13		Status DO 12	

Status DO: 00 = OK / 01 = short circuit to GND / 10 = 24 V load voltage (L+) missing

Technical specifications

Order no.	600-220-0AP21
Name	DO 16 x DC 24 V, 500 mA
Module ID / module type	2910 _{dec.} / 0x1190
Number of outputs	16
Electrically isolated from backplane bus	Yes
Channels electrically isolated from each other	No
Supply voltage U_p , U_s	
Rated	24 V DC
Ripple U_{ss}	Max. 3.6 V
Permissible range (with ripple)	20 ... 30 V
Voltage for $t < 10$ ms	50 V
Output current	
Rated	700 mA
Leakage current	Max. 0.5 mA
Current draw	
External	Max. 80 mA + load
Internal	Max. 47 mA
Power dissipation	Max. 2.5 W
Diagnoses	No external reference voltage (load voltage L+) Short circuit to GND Parameter assignment error
Output short-circuit protection	Electronic, for each individual channel
Inductive cutoff voltage limit	-48 V
Weight	Approx. 110 g
Certification	UL 508

5.2.10. 600-220-0BB01, DO 2 x DC 24 V, 2 A

Characteristics

- 2 outputs, electrically isolated from the backplane bus
- 24 V DC output voltage
- 2 A output voltage per channel
- A blue LED indicates the module's operating status
- Green LEDs (one for each output) indicate the outputs' states

Pin assignment

Connection	I/O
1	Output 0
2	Output 1
3	GND
4	GND
5	L+, 24 VDC
6	L+, 24 VDC
7	AUX
8	AUX
9	L+, 24 VDC
10	AUX

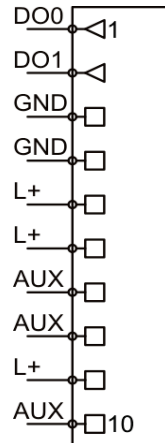

Technical data

Order no.	600-220-0BB01
Name	DO 2 x DC 24 V, 2 A
Module ID / module type	2220 _{dec.} / 0x0120
Number of outputs	2
Electrically isolated from backplane bus	Yes
Channels electrically isolated from each other	No
Supply voltage U_p , U_s	
Rated	24 V DC
Ripple U_{ss}	Max. 3.6 V
Permissible range (with ripple)	20 ... 30 V
Voltage for $t < 10$ ms	50 V
Output current	
Rated	2 A
Leakage current	Max. 0.5 mA
Current draw	
External	Max. 20 mA + load
Internal	Max. 30 mA
Power dissipation	Max. 0.7 W
Output short-circuit protection	Electronic, for each individual channel
Inductive cutoff voltage limit	-48 V
Weight	Approx. 70 g
Certification	UL 508

5.2.11. 600-220-0BD01, DO 4 x DC 24 V, 2 A

Characteristics

- 4 outputs, electrically isolated from the backplane bus
- 24 V DC output voltage
- 2 A output voltage per channel
- A blue LED indicates the module's operating status
- Green LEDs (one for each output) indicate the outputs' states

Pin assignment

Connection	I/O
1	Output 0
2	Output 1
3	Output 2
4	Output 3
5	L+, 24 VDC
6	L+, 24 VDC
7	AUX
8	AUX
9	L+, 24 VDC
10	AUX

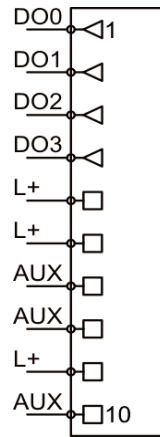

Technical data

Order no.	600-220-0BD01
Name	DO 4 x DC 24 V, 2 A
Module ID / module type	2420 _{dec.} / 0x0140
Number of outputs	4
Electrically isolated from backplane bus	Yes
Channels electrically isolated from each other	No
Supply voltage U_p , U_s	
Rated	24 V DC
Ripple U_{ss}	Max. 3.6 V
Permissible range (with ripple)	20 ... 30 V
Voltage for $t < 10$ ms	50 V
Output current	
Rated	2 A
Leakage current	Max. 0.5 mA
Current draw	
External	Max. 30 mA + load
Internal	Max. 30 mA
Power dissipation	Max. 1.1 W
Output short-circuit protection	Electronic, for each individual channel
Inductive cutoff voltage limit	-48 V
Weight	Approx. 70 g
Certification	UL 508

5.2.12. 600-222-0AB01, DO 2 x relay, AC 230 V, 5 A, changeover

Characteristics

- Dry contact switching
- Two changeover relays
- 5 A output voltage per relay
- Up to 230 V AC switching voltage per relay
- Switching operation counter: 2x input words (switching operations *1000) [optional with Profibus-DP]
- Transient filter for protection against high-frequency relay switching (10 Hz)
- A blue LED indicates the module's operating status
- Green LEDs (one for each output) indicate the outputs' states

Pin assignment

Connection	I/O
1	Relay 0, "normally closed"
2	Relay 0, "common"
3	Relay 0, "normally open"
4	n.c.
5	Relay 1, "normally closed"
6	Relay 1, "common"
7	Relay 1, "normally open"
8	n.c.
9	L+, 24 VDC
10	AUX

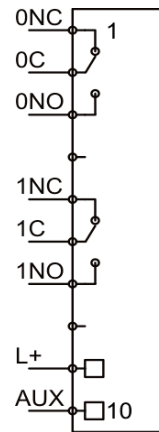

Technical data

Order no.	600-222-0AB01
Name	DO 2 x relay, AC 230 V, 5 A, changeover
Module ID / module type	2260 _{dec.} / 0x0120
Number of outputs	4 (2 changeover relays)
Electrically isolated from backplane bus	Yes
Channels electrically isolated from each other	Yes
Supply voltage U_p , U_s	
Rated	24 V DC
Ripple U_{ss}	Max. 3.6 V
Permissible range (with ripple)	20 ... 30 V
Voltage for $t < 10$ ms	50 V
Current draw	
External	Max. 30 mA
Internal	Max. 30 mA
Power dissipation	Max. 1.5 W
Relays	2
Max. continuous current / max. inrush current	5 A / 10 A
Rated voltage / max. switching voltage	250 V AC / 400 V AC
Max. switching power for utilization category AC1	1500 VA

Max. switching power for utilization category AC15 (230 VAC)	300 VA
Single-phase motor load, utilization category AC-3 – running (230 VAC)	0.185 kW
Max. switching current for utilization category DC1: 30/110/220 V	6 / 0.2 / 0.12 A
Min. switching capacity	500 mW (12 V / 10 mA)
Mechanical life (AC / DC)	- / 10 * 10 ⁶ switching operations
Electrical life for utilization category AC1	60,000 switching operations
Dielectric strength, coil to contact	6 kV (8 mm)
Dielectric strength across open contacts	1000 VAC
Maximum switching frequency (internal protection)	10 Hz
Weight	Approx. 80 g
Certification	UL 508

5.2.13. 600-222-0AD21, DO 4 x relay, AC 230 V, 5 A, changeover

Characteristics

- Dry contact switching
- Four changeover relays
- 5 A output voltage per relay
- Up to 230 V AC switching voltage per relay
- Switching operation counter: 4x input words (switching operations *1000) [optional with Profibus-DP]
- Transient filter for protection against high-frequency relay switching (10 Hz)
- A blue LED indicates the module's operating status
- Green LEDs (one for each output) indicate the outputs' states

Pin assignment

Connection	I/O	Connection	I/O
1	Relay 0, "normally closed"	11	Relay 0, "normally closed"
2	Relay 0, "common"	12	Relay 0, "common"
3	Relay 0, "normally open"	13	Relay 0, "normally open"
4	n.c.	14	n.c.
5	Relay 1, "normally closed"	15	Relay 1, "normally closed"
6	Relay 1, "common"	16	Relay 1, "common"
7	Relay 1, "normally open"	17	Relay 1, "normally open"
8	n.c.	18	n.c.
9	L+, 24 VDC	19	L+, 24 VDC
10	AUX	20	AUX

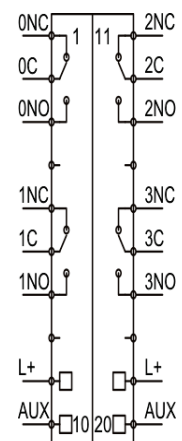

Technical data

Order no.	600-222-0AD21
Name	DO 2 x relay, AC 230 V, 5 A, changeover
Module ID / module type	2460 _{dec.} / 0x0140
Number of outputs	8 (4 changeover relays)
Electrically isolated from backplane bus	Yes
Channels electrically isolated from each other	Yes
Supply voltage U_p , U_s	
Rated	24 V DC
Ripple U_{ss}	Max. 3.6 V
Permissible range (with ripple)	20 ... 30 V
Voltage for $t < 10$ ms	50 V
Current draw	
External	Max. 60 mA
Internal	Max. 60 mA
Power dissipation	Max. 2.5 W
Relays	4
Max. continuous current / max. inrush current	5 A / 10 A
Rated voltage / max. switching voltage	250 V AC / 400 V AC
Max. switching power for utilization category AC1	1500 VA
Max. switching power for utilization category AC15 (230 VAC)	300 VA
Single-phase motor load, utilization category AC-3 – running (230 VAC)	0.185 kW
Max. switching current for utilization category DC1: 30/110/220 V	6 / 0.2 / 0.12 A
Min. switching capacity	500 mW (12 V / 10 mA)
Mechanical life (AC / DC)	- / $10 \cdot 10^6$ switching operations
Electrical life for utilization category AC1	60,000 switching operations
Dielectric strength, coil to contact	6 kV (8 mm)
Dielectric strength across open contacts	1000 VAC
Maximum switching frequency (internal protection)	10 Hz
Weight	Approx. 120 g
Certification	UL 508

5.3. Digital Input/Output Modules

5.3.1. 600-230-0AD01, DIO 2 x In / 2 x Out DC 24 V, 500 mA

Characteristics

- 2 inputs, electrically isolated from the backplane bus
- 24 V DC input voltage
- Can accommodate 2-wire proximity sensors
- 2 outputs, electrically isolated from the backplane bus
- 24 VDC output voltage
- 500 mA output voltage per channel
- A blue LED indicates the module's operating status
- Green LEDs (one for each input/output) indicate the inputs' and outputs' states

Pin assignment

Connection	I/O
1	Input 0
2	Input 1
3	L+, 24 VDC
4	L+, 24 VDC
5	Output 0
6	Output 1
7	AUX
8	AUX
9	L+, 24 VDC
10	AUX

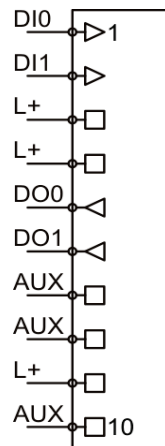

Technical data

Order no.	600-230-0AD01
Name	DIO 2 x In / 2 x Out DC 24 V, 500 mA
Module ID / module type	3200 _{dec.} / 0x0122
Number of inputs	2
Input characteristic curve	Type 2, EN 61131-2
Reverse polarity protection for inputs	Yes
Input voltage	
For signal "0"	-3 V to 9 V
For signal "1"	12 V to 30 V
Number of outputs	2
Supply voltage U_p , U_s	
Rated	24 V DC
Ripple U_{ss}	Max. 3.6 V
Permissible range (with ripple)	20 ... 30 V
Voltage for $t < 10$ ms	50 V
Output current	
Rated	500 mA

Leakage current	Max. 0.5 mA
Output short-circuit protection	Electronic, for each individual channel
Inductive cutoff voltage limit	-48 V
Current draw	
External	Max. 10 mA + load
Internal	Max. 25 mA
Power dissipation	Max. 1.2 W
Electrically isolated from backplane bus	Yes
Channels electrically isolated from each other	No
Weight	Approx. 70 g
Certification	UL 508

5.3.2. 600-230-0AH01, DIO 4 x In / 4 x Out DC 24 V, 500 mA

Characteristics

- 4 inputs, electrically isolated from the backplane bus
- 24 V DC input voltage
- Can accommodate 2-wire proximity sensors
- 4 outputs, electrically isolated from the backplane bus
- 24 VDC output voltage
- 500 mA output voltage per channel
- A blue LED indicates the module's operating status
- Green LEDs (one for each input/output) indicate the inputs' and outputs' states

Pin assignment

Connection	I/O
1	Input 0
2	Input 1
3	Input 2
4	Input 3
5	Output 0
6	Output 1
7	Output 2
8	Output 3
9	L+, 24 VDC
10	AUX

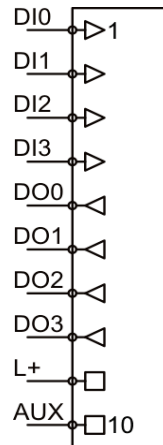

Technical data

Order no.	600-230-0AH01
Name	DIO 4 x In / 4 x Out DC 24 V, 500 mA
Module ID / module type	3400 _{dec.} / 0x0144
Number of inputs	4
Input characteristic curve	Type 2, EN 61131-2
Reverse polarity protection for inputs	Yes
Input voltage	
For signal "0"	-3 V to 9 V
For signal "1"	12 V to 30 V
Number of outputs	4
Supply voltage U_p , U_s	
Rated	24 V DC
Ripple U_{ss}	Max. 3.6 V
Permissible range (with ripple)	20 ... 30 V
Voltage for $t < 10$ ms	50 V
Output current	
Rated	500 mA
Leakage current	Max. 0.5 mA

Output short-circuit protection	Electronic, for each individual channel
Inductive cutoff voltage limit	-48 V
Current draw	
External	Max. 20 mA + load
Internal	Max. 28 mA
Power dissipation	Max. 1.95 W
Electrically isolated from backplane bus	Yes
Channels electrically isolated from each other	No
Weight	Approx. 70 g
Certification	UL 508

5.3.3. 600-230-0AP21, DIO 8 x Out / 8 x In DC 24 V, 500 mA

Characteristics

- 8 inputs, electrically isolated from the backplane bus
- 24 V DC input voltage
- Can accommodate 2-wire proximity sensors
- 8 outputs, electrically isolated from the backplane bus
- 24 VDC output voltage
- 500 mA output voltage per channel
- A blue LED indicates the module's operating status
- Green LEDs (one for each input/output) indicate the inputs' and outputs' states

Pin assignment

Connection	I/O	Connection	I/O
1	Output 0	11	Input 0
2	Output 1	12	Input 1
3	Output 2	13	Input 2
4	Output 3	14	Input 3
5	Output 4	15	Input 4
6	Output 5	16	Input 5
7	Output 6	17	Input 6
8	Output 7	18	Input 7
9	L+, 24 VDC	19	L+, 24 VDC
10	AUX	20	AUX

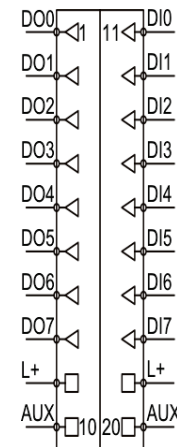

Technical data

Order no.	600-230-0AP21
Name	DIO 8 x Out / 8 x In DC 24 V, 500 mA
Module ID / module type	3800 _{dec.} / 0x0188
Number of inputs	8
Input characteristic curve	Type 2, EN 61131-2
Reverse polarity protection for inputs	Yes
Input voltage	
For signal "0"	-3 V to 9 V
For signal "1"	12 V to 30 V
Number of outputs	8
Supply voltage U_p , U_s	
Rated	24 V DC
Ripple U_{ss}	Max. 3.6 V
Permissible range (with ripple)	20 ... 30 V
Magnitude for $t < 10$ ms	50 V
Output current	
Rated	500 mA
Leakage current	Max. 0.5 mA

Output short-circuit protection	Electronic, for each individual channel
Inductive cutoff voltage limit	-48 V
Current draw	
External	Max. 40 mA + load
Internal	Max. 35 mA
Power dissipation	Max. 4.35 W
Electrically isolated from backplane bus	Yes
Channels electrically isolated from each other	No
Weight	Approx. 110 g
Certification	UL 508

6. Analog modules

6.1. Analog Input Modules

6.1.1. 600-250-4AB01, AI 2 x I, 0/4-20 mA, ±20 mA, 12-bit

Characteristics

- 2 analog inputs for measuring current, electrically isolated from the backplane bus
- 2 process input words
- Measuring ranges 0 ... 20 mA, 4 ... 20 mA, ±20 mA, individually configurable for each channel
- Measurement resolution: up to 12 bits + sign
- Diagnostic messages
- Wire break detection (for 4 ... 20 mA)
- Limit value alarms for each channel
- A bi-color LED (blue/red) indicates the module's operating status and any malfunctions

Pin assignment

Connection	I/O
1	AI0 +
2	AI0 -
3	AI1 +
4	AI1 -
5	L+, 24 VDC
6	L+, 24 VDC
7	L-, GND
8	L-, GND
9	Mana
10	AUX

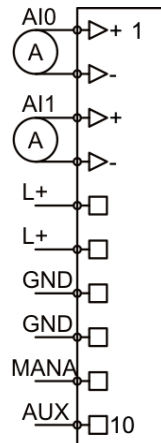

Parameters for the module

Diagnostic alarm: ON / OFF

Overflow / underflow diagnosis: ON / OFF

Format of values: Simatic S7 / Simatic S5 / INT16

Parameters for each channel

Wire break detection (*for 4–20 mA only*): ON / OFF

Interference frequency suppression: None / 10 Hz / 50 Hz / 60 Hz / 400 Hz

Measuring range: deactivated / 0 ... 20 mA / 4 ... 20 mA / ±20 mA

Limit value alarms enabled: ON / OFF

Upper / lower limit: 16-bit analog value (±27648)

Technical specifications

Order no.	600-250-4AB01
Name	AI 2 x I 0/4–20 mA, ±20 mA, 12-bit
Module ID / module type	4200 _{dec.} / 0x0202
Number of inputs	2
Electrically isolated from backplane bus	Yes
Channels electrically isolated from each other	No
Current draw	
External	Not needed
Internal	Max. 95 mA
Power dissipation	Max. 0.7 W
Measuring ranges / load resistance	0 ... 20 mA / 50 ohms 4 ... 20 mA / 50 ohms ±20 mA / 50 ohms
Measurement resolution	12 bits + sign
Measuring method	Integration
Interference frequency suppression	None / 10 Hz / 50 Hz / 60 Hz / 400 Hz
Refresh rate / conversion rate	Number of active channels x conversion time + 16 ms for wire break detection for each channel when activated <i>The conversion time depends on the interference frequency suppression:</i> None: 8 ms 400 Hz: 45 ms 60 Hz: 109 ms 50 Hz: 128 ms 10 Hz: 342 ms
Diagnoses	Upper measuring limit exceeded (overflow) Lower measuring limit fallen below (underflow) Wire break (<i>only for 4 ...</i>) 20 mA) Configuration error
Process alarms	Upper and lower limit per channel
Error limits	
Operational error limit	±0.5% within the entire temperature range, relative to the nominal range
Basic error limit	±0.3%, operational error limit at 25°C, relative to the nominal range
Temperature error	±0.005%/K, relative to the nominal range
Linearity error	±0.05%/K, relative to the nominal range
Repeating accuracy in steady state at 25 °C	±0.05%/K, relative to the nominal range
Parameter configuration length	12 bytes
General error indicator	Red LED
Weight	Approx. 70 g
Certification	UL 508

6.1.2. 600-250-4AD01, AI 4 x I, 0/4-20 mA, ±20 mA, 12-bit

Characteristics

- 4 analog inputs for measuring current, electrically isolated from the backplane bus
- 4 process input words
- Measuring ranges 0 ... 20 mA, 4 ... 20 mA, ±20 mA, individually configurable for each channel
- Measurement resolution: up to 12 bits + sign
- Diagnostic messages
- Wire break detection (for 4 ... 20 mA)
- Limit value alarms for each channel
- A bi-color LED (blue/red) indicates the module's operating status and any malfunctions

Pin assignment

Connection	I/O
1	AI0 +
2	AI0 -
3	AI1 +
4	AI1 -
5	AI2 +
6	AI2 -
7	AI3 +
8	AI3 -
9	Mana
10	AUX

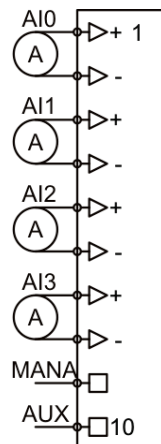

Parameters for the module

Diagnostic alarm: ON / OFF

Overflow / underflow diagnosis: ON / OFF

Format of values: Simatic S7 / Simatic S5 / INT16

Parameters for each channel

Wire break detection (*for 4–20 mA only*): ON / OFF

Interference frequency suppression: None / 10 Hz / 50 Hz / 60 Hz / 400 Hz

Measuring range: deactivated / 0 ... 20 mA / 4 ... 20 mA / ±20 mA

Limit value alarms enabled: ON / OFF

Upper / lower limit: 16-bit analog value (±27648)

Technical specifications

Order no.	600-250-4AD01
Name	AI 4 x I 0/4–20 mA, ±20 mA, 12-bit
Module ID / module type	4400 _{dec.} / 0x0204
Number of inputs	4
Electrically isolated from backplane bus	Yes
Channels electrically isolated from each other	No
Current draw	
External	Not needed
Internal	Max. 95 mA
Power dissipation	Max. 0.7 W
Measuring ranges / load resistance	0 ... 20 mA / 50 ohms 4 ... 20 mA / 50 ohms ±20 mA / 50 ohms
Measurement resolution	12 bits + sign
Measuring method	Integration
Interference frequency suppression	None / 10 Hz / 50 Hz / 60 Hz / 400 Hz
Refresh rate / conversion rate	Number of active channels x conversion time + 16 ms for wire break detection for each channel when activated <i>The conversion time depends on the interference frequency suppression:</i> None: 8 ms 400 Hz: 45 ms 60 Hz: 109 ms 50 Hz: 128 ms 10 Hz: 342 ms
Diagnoses	Upper measuring limit exceeded (overflow) Lower measuring limit fallen below (underflow) Wire break (for 4–20 mA only) Parameter assignment error
Process alarms	Upper and lower limit per channel
Error limits	
Operational error limit	±0.5% within the entire temperature range, relative to the nominal range
Basic error limit	±0.3%, operational error limit at 25 °C, relative to the nominal range
Temperature error	±0.005%/K, relative to the nominal range
Linearity error	±0.05%/K, relative to the nominal range
Repeating accuracy in steady state at 25 °C	±0.05%/K, relative to the nominal range
Parameter configuration length	22 bytes
General error indicator	Red LED
Weight	Approx. 70 g
Certification	UL 508

6.1.3. 600-250-7BB01, AI 2 x I, 0/4-20 mA, ±20 mA, Iso., 16-bit

Characteristics

- 2 analog inputs for measuring current
- Channels electrically isolated from each other and from the backplane bus
- 2 process input words
- Measuring ranges 0 ... 20 mA, 4 ... 20 mA, ±20 mA, individually configurable for each channel
- Measurement resolution: up to 15 bits + sign
- Diagnostic messages
- Red/green bi-color LEDs (one for each channel) indicate the channels' states
- Wire break detection (for 4 ... 20 mA)
- Limit value alarms for each channel
- A bi-color LED (blue/red) indicates the module's operating status and any malfunctions

Pin assignment

Connection	I/O
1	AI0 +
2	AI0 -
3	AI1 +
4	AI1 -
5	n.c.
6	n.c.
7	n.c.
8	n.c.
9	n.c.
10	AUX

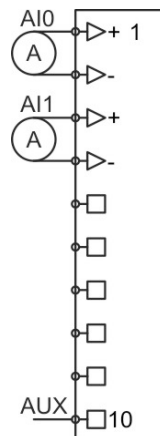

Channel LED signals:

Flashing red light = Parameter assignment error on channel

Solid red light = Reading overflow/underflow or wire break

Flashing green light = Reading within overdrive range

Solid green light = Channel configured, normal reading

Off = Channel disabled or module not yet configured

Parameters for the module

Diagnostic alarm: ON / OFF

Overflow / underflow diagnosis: ON / OFF

Format of values: Simatic S7 / Simatic S5 / INT16

Parameters for each channel

Wire break detection (*for 4-20 mA only*): ON / OFF

Interference frequency suppression: None / 10 Hz / 50 Hz / 60 Hz / 400 Hz

Measuring range: deactivated / 0 ... 20 mA / 4 ... 20 mA / ± 20 mA

Limit value alarms enabled: ON / OFF

Upper / lower limit: 16-bit analog value (± 27648)

Technical specifications

Order no.	600-250-7BB01
Name	AI 2 x I, 0/4–20 mA, ± 20 mA, Iso., 16-bit
Module ID / module type	4210 _{dec.} / 0x0202
Number of inputs	2
Electrically isolated from backplane bus	Yes
Channels electrically isolated from each other	Yes
Current draw	
External	Not needed
Internal	Max. 140 mA
Power dissipation	Max. 1 W
Measuring ranges / load resistance	0 ... 20 mA / 50 ohms 4 ... 20 mA / 50 ohms ± 20 mA / 50 ohms
Measurement resolution	15 bits + sign
Measuring method	Integration
Interference frequency suppression	None / 10 Hz / 50 Hz / 60 Hz / 400 Hz
Refresh rate / conversion rate	<i>Depends on the interference frequency suppression setting being used:</i> None: 2 ms 400 Hz: 8 ms 60 Hz: 51 ms 50 Hz: 60 ms 10 Hz: 160 ms
Diagnoses	Upper measuring limit exceeded (overflow) Lower measuring limit fallen below (underflow) Wire break (for 4-20 mA only) Configuration error
Process alarms	Upper and lower limit per channel
Error limits	
Operational error limit	$\pm 0.2\%$ within the entire temperature range, relative to the nominal range
Basic error limit	$\pm 0.1\%$, operational error limit at 25°C, relative to the nominal range
Temperature error	$\pm 0.005\%/K$, relative to the nominal range
Linearity error	$\pm 0.05\%/K$, relative to the nominal range
Repeating accuracy in steady state at 25 °C	$\pm 0.05\%/K$, relative to the nominal range
Parameter configuration length	13 bytes
General error indicator	Red LED
Weight	Approx. 70 g
Certification	UL 508

6.1.4. 600-250-7BD01, AI 4 x I, 0/4-20 mA, ±20 mA, Iso., 16-bit

Characteristics

- 4 analog inputs for measuring current
- Channels electrically isolated from each other and from the backplane bus
- 4 process input words
- Measuring ranges 0 ... 20 mA, 4 ... 20 mA, ±20 mA, individually configurable for each channel
- Measurement resolution: up to 15 bits + sign
- Diagnostic messages
- Red/green bi-color LEDs (one for each channel) indicate the channels' states
- Wire break detection (for 4 ... 20 mA)
- Limit value alarms for each channel
- A bi-color LED (blue/red) indicates the module's operating status and any malfunctions

Pin assignment

Connection	I/O
1	AI0 +
2	AI0 -
3	AI1 +
4	AI1 -
5	AI2 +
6	AI2 -
7	AI3 +
8	AI3 -
9	n.c.
10	AUX

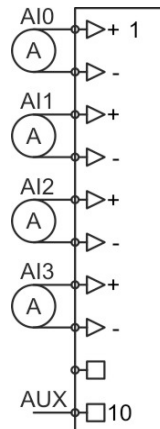

Channel LED signals:

Flashing red light = Parameter assignment error on channel

Solid red light = Reading overflow/underflow or wire break

Flashing green light = Reading within overdrive range

Solid green light = Channel configured, normal reading

Off = Channel disabled or module not yet configured

Parameters for the module

Diagnostic alarm: ON / OFF

Overflow / underflow diagnosis: ON / OFF

Format of values: Simatic S7 / Simatic S5 / INT16

Parameters for each channel

Wire break detection (*for 4–20 mA only*): ON / OFF

Interference frequency suppression: None / 10 Hz / 50 Hz / 60 Hz / 400 Hz

Measuring range: deactivated / 0 ... 20 mA / 4 ... 20 mA / ± 20 mA

Limit value alarms enabled: ON / OFF

Upper / lower limit: 16-bit analog value (± 27648)

Technical specifications

Order no.	600-250-7BD01
Name	AI 4 x I, 0/4–20 mA, ± 20 mA, Iso., 16-bit
Module ID / module type	4410 _{dec.} / 0x0204
Number of inputs	4
Electrically isolated from backplane bus	Yes
Channels electrically isolated from each other	Yes
Current draw	
External	Not needed
Internal	Max. 140 mA
Power dissipation	Max. 1 W
Measuring ranges / load resistance	0 ... 20 mA / 50 ohms 4 ... 20 mA / 50 ohms ± 20 mA / 50 ohms
Measurement resolution	15 bits + sign
Measuring method	Integration
Interference frequency suppression	None / 10 Hz / 50 Hz / 60 Hz / 400 Hz
Refresh rate / conversion rate	<i>Depends on the interference frequency suppression setting being used:</i> None: 2.5 ms 400 Hz: 8 ms 60 Hz: 51 ms 50 Hz: 60 ms 10 Hz: 160 ms
Diagnoses	Upper measuring range exceeded (overflow) Lower measuring range fallen below (underflow) Wire break (for 4–20 mA only) Parameter assignment error
Process alarms	Upper and lower limit per channel
Error limits	
Operational error limit	$\pm 0.2\%$ within the entire temperature range, relative to the nominal range
Basic error limit	$\pm 0.1\%$, operational error limit at 25 °C, relative to the nominal range
Temperature error	$\pm 0.005\%/K$, relative to the nominal range
Linearity error	$\pm 0.05\%/K$, relative to the nominal range
Repeating accuracy in steady state at 25 °C	$\pm 0.05\%/K$, relative to the nominal range
Parameter configuration length	23 bytes
General error indicator	Red LED
Weight	Approx. 80 g
Certification	UL 508

6.1.5. 600-250-7BH21, AI 8 x I, 0/4-20 mA, ±20 mA, Iso., 16-bit

Characteristics

- 8 analog inputs for measuring current
- Channels electrically isolated from each other and from the backplane bus
- 8 process input words
- Measuring ranges 0 ... 20 mA, 4 ... 20 mA, ±20 mA, individually configurable for each channel
- Measurement resolution: up to 15 bits + sign
- Red/green bi-color LEDs (one for each channel) indicate the channels' states
- Diagnostic messages
- Wire break detection (for 4 ... 20 mA)
- Limit value alarms for each channel
- A bi-color LED (blue/red) indicates the module's operating status and any malfunctions

Pin assignment

Connection	I/O	Connection	I/O
1	AI0 +	11	AI4 +
2	AI0 -	12	AI4 -
3	AI1 +	13	AI5 +
4	AI1 -	14	AI5 -
5	AI2 +	15	AI6 +
6	AI2 -	16	AI6 -
7	AI3 +	17	AI7 +
8	AI3 -	18	AI7 -
9	n.c.	19	n.c.
10	AUX	20	AUX

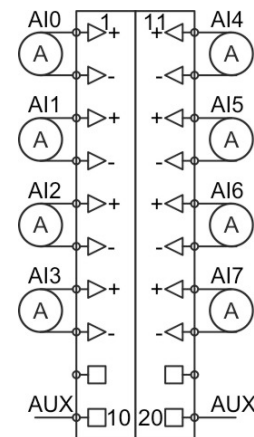

Channel LED signals:

Flashing red light = Parameter assignment error on channel

Solid red light = Reading overflow/underflow or wire break

Flashing green light = Reading within overdrive range

Solid green light = Channel configured, normal reading

Off = Channel disabled or module not yet configured

Parameters for the module

Diagnostic alarm: ON / OFF

Overflow / underflow diagnosis: ON / OFF

Format of values: Simatic S7 / Simatic S5 / INT16

Parameters for each channel

Wire break detection (*for 4–20 mA only*): ON / OFF

Interference frequency suppression: None / 10 Hz / 50 Hz / 60 Hz / 400 Hz

Measuring range: deactivated / 0 ... 20 mA / 4 ... 20 mA / ± 20 mA

Limit value alarms enabled: ON / OFF

Upper / lower limit: 16-bit analog value (± 27648)

Technical specifications

Order no.	600-250-7BH21
Name	AI 8 x I, 0/4–20 mA, ± 20 mA, Iso., 16-bit
Module ID / module type	4810 _{dec.} / 0x0208
Number of inputs	8
Electrically isolated from backplane bus	Yes
Channels electrically isolated from each other	Yes
Current draw	
External	Not needed
Internal	Max. 140 mA
Power dissipation	Max. 1 W
Measuring ranges / load resistance	0 ... 20 mA / 50 ohms 4 ... 20 mA / 50 ohms ± 20 mA / 50 ohms
Measurement resolution	15 bits + sign
Measuring method	Integration
Interference frequency suppression	None / 10 Hz / 50 Hz / 60 Hz / 400 Hz
Refresh rate / conversion rate	<i>Depends on the interference frequency suppression setting being used:</i> None: 3 ms 400 Hz: 8 ms 60 Hz: 51 ms 50 Hz: 60 ms 10 Hz: 160 ms
Diagnoses	Upper measuring limit exceeded (overflow) Lower measuring limit fallen below (underflow) Wire break (for 4–20 mA only) Parameter assignment error
Process alarms	Upper and lower limit per channel
Error limits	
Operational error limit	$\pm 0.2\%$ within the entire temperature range, relative to the nominal range
Basic error limit	$\pm 0.1\%$, operational error limit at 25 °C, relative to the nominal range
Temperature error	$\pm 0.005\%/K$, relative to the nominal range
Linearity error	$\pm 0.05\%/K$, relative to the nominal range
Repeating accuracy in steady state at 25 °C	$\pm 0.05\%/K$, relative to the nominal range
Parameter configuration length	44 bytes
General error indicator	Red LED
Weight	Approx. 110 g
Certification	UL 508

6.1.6. 600-252-4AB01, AI 2 x U, ±10 V, 0–10 V, 1–5 V, 12-bit

Characteristics

- 2 analog inputs for measuring voltage (electrically isolated from the backplane bus)
- 2 process input words
- Measuring ranges 0 ... 10 V, 1 ... 5 V, ±10 V, ±5 V, ±2.5 V, individually configurable for each channel
- Measurement resolution: up to 12 bits + sign
- Diagnostic messages
- Wire break detection (for 1 ... 5V)
- Limit value alarms for each channel
- A bi-color LED (blue/red) indicates the module's operating status and any malfunctions

Pin assignment

Connection	I/O
1	AI0 +
2	AI0 -
3	AI1 +
4	AI1 -
5	L+, 24 VDC
6	L+, 24 VDC
7	L-, GND
8	L-, GND
9	Mana
10	AUX

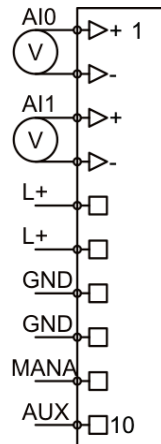

Parameters for the module

Diagnostic alarm: ON / OFF

Overflow / underflow diagnosis: ON / OFF

Format of values: Simatic S7 / Simatic S5 / INT16

Parameters for each channel

Wire break detection (*for 1–5 V only*): ON / OFF

Interference frequency suppression: None / 10 Hz / 50 Hz / 60 Hz / 400 Hz

Measuring range: deactivated / 0 ... 10 V / 1 ... 5 V / ±10 V / ±5 V / ±2.5 V

Limit value alarms enabled: ON / OFF

Upper / lower limit: 16-bit analog value (±27648)

Technical specifications

Order no.	600-252-4AB01
Name	AI 2 x U, ± 10 V, 0–10 V, 1–5 V, 12-bit
Module ID / module type	5200 _{dec.} / 0x0202
Number of inputs	2
Electrically isolated from backplane bus	Yes
Channels electrically isolated from each other	No
Current draw	
External	Not needed
Internal	Max. 95 mA
Power dissipation	Max. 0.7 W
Measuring ranges / load resistance	0 ... 10 V / 10 Mohms 1 ... 5 V / 10 Mohms ± 10 V / 10 Mohms ± 5 V / 10 Mohms ± 2.5 V / 10 Mohms
Measurement resolution	12 bits + sign
Measuring method	Integration
Interference frequency suppression	None / 10 Hz / 50 Hz / 60 Hz / 400 Hz
Refresh rate / conversion rate	Number of active channels x conversion time + 16 ms for wire break detection for each channel when activated <i>The conversion time depends on the interference frequency suppression:</i> None: 8 ms 400 Hz: 45 ms 60 Hz: 109 ms 50 Hz: 128 ms 10 Hz: 342 ms
Diagnoses	Upper measuring limit exceeded (overflow) Lower measuring limit fallen below (underflow) Wire break (<i>for 1–5 V only</i>) Parameter assignment error
Process alarms	Upper and lower limit per channel
Error limits	
Operational error limit	$\pm 0.5\%$ within the entire temperature range, relative to the nominal range
Basic error limit	$\pm 0.3\%$, operational error limit at 25 °C, relative to the nominal range
Temperature error	$\pm 0.005\%/K$, relative to the nominal range
Linearity error	$\pm 0.05\%/K$, relative to the nominal range
Repeating accuracy in steady state at 25 °C	$\pm 0.05\%/K$, relative to the nominal range
Parameter configuration length	12 bytes
General error indicator	Red LED
Weight	Approx. 70 g
Certification	UL 508

6.1.7. 600-252-4AD01, AI 4 x U, ±10 V, 0–10 V, 1–5 V, 12-bit

Characteristics

- 4 analog inputs for measuring voltage (electrically isolated from the backplane bus)
- 4 process input words
- Measuring ranges 0 ... 10 V, 1 ... 5 V, ±10 V, ±5 V, ±2.5 V, individually configurable for each channel
- Measurement resolution: up to 12 bits + sign
- Diagnostic messages
- Wire break detection (for 1–5 V)
- Limit value alarms for each channel
- A bi-color LED (blue/red) indicates the module's operating status and any malfunctions

Pin assignment

Connection	I/O
1	AI0 +
2	AI0 -
3	AI1 +
4	AI1 -
5	AI2 +
6	AI2 -
7	AI3 +
8	AI3 -
9	Mana
10	AUX

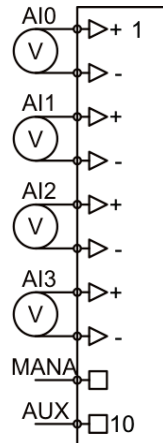

Parameters for the module

Diagnostic alarm: ON / OFF

Overflow / underflow diagnosis: ON / OFF

Format of values: Simatic S7 / Simatic S5 / INT16

Parameters for each channel

Wire break detection (*for 1-5V only*): ON / OFF

Interference frequency suppression: None / 10 Hz / 50 Hz / 60 Hz / 400 Hz

Measuring range: deactivated / 0 ... 10 V / 1 ... 5 V / ±10 V / ±5 V / ±2.5 V

Limit value alarms enabled: ON / OFF

Upper / lower limit: 16-bit analog value (±27648)

Technical specifications

Order no.	600-252-4AD01
Name	AI 4 x U, ± 10 V, 0–10 V, 1–5 V, 12-bit
Module ID / module type	5400 _{dec.} / 0x0204
Number of inputs	4
Electrically isolated from backplane bus	Yes
Channels electrically isolated from each other	No
Current draw	
External	Not needed
Internal	Max. 95 mA
Power dissipation	Max. 0.7 W
Measuring ranges / load resistance	0 ... 10 V / 10 Mohms 1 ... 5 V / 10 Mohms ± 10 V / 10 Mohms ± 5 V / 10 Mohms ± 2.5 V / 10 Mohms
Measurement resolution	12 bits + sign
Measuring method	Integration
Interference frequency suppression	None / 10 Hz / 50 Hz / 60 Hz / 400 Hz
Refresh rate / conversion rate	Number of active channels x conversion time + 16 ms for wire break detection for each channel when activated <i>The conversion time depends on the interference frequency suppression:</i> None: 8 ms 400 Hz: 45 ms 60 Hz: 109 ms 50 Hz: 128 ms 10 Hz: 342 ms
Diagnoses	Upper measuring limit exceeded (overflow) Lower measuring limit fallen below (underflow) Wire break (<i>for 1-5 V only</i>) Configuration error
Process alarms	Upper and lower limit per channel
Error limits	
Operational error limit	$\pm 0.5\%$ within the entire temperature range, relative to the nominal range
Basic error limit	$\pm 0.3\%$, operational error limit at 25 °C, relative to the nominal range
Temperature error	$\pm 0.005\%/K$, relative to the nominal range
Linearity error	$\pm 0.05\%/K$, relative to the nominal range
Repeating accuracy in steady state at 25 °C	$\pm 0.05\%/K$, relative to the nominal range
Parameter configuration length	22 bytes
General error indicator	Red LED
Weight	Approx. 70 g
Certification	UL 508

6.1.8. 600-252-7BB01, AI 2 x U, ±10 V, 0–10 V, 1–5 V, Iso., 16-bit

Characteristics

- 2 analog inputs for measuring voltage
- Channels electrically isolated from each other and from the backplane bus
- 2 process input words
- Measuring ranges 0 ... 10 V, 1 ... 5 V, ±10 V, ±5 V, ±2.5 V, individually configurable for each channel
- Measurement resolution: up to 15 bits + sign
- Diagnostic messages
- Red/green bi-color LEDs (one for each channel) indicate the channels' states
- Wire break detection (for 1 ... 5V)
- Limit value alarms for each channel
- A bi-color LED (blue/red) indicates the module's operating status and any malfunctions

Pin assignment

Connection	I/O
1	AI0 +
2	AI0 -
3	AI1 +
4	AI1 -
5	n.c.
6	n.c.
7	n.c.
8	n.c.
9	n.c.
10	AUX

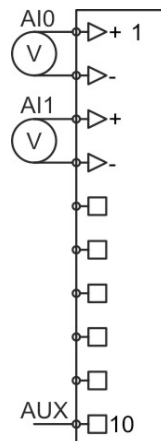

Channel LED signals:

Flashing red light = Parameter assignment error on channel

Solid red light = Reading overflow/underflow or wire break

Flashing green light = Reading within overdrive range

Solid green light = Channel configured, normal reading

Off = Channel disabled or module not yet configured

Parameters for the module

Diagnostic alarm: ON / OFF

Overflow / underflow diagnosis: ON / OFF

Format of values: Simatic S7 / Simatic S5 / INT16

Parameters for each channel

Wire break detection (*for 1–5 V only*): ON / OFF

Interference frequency suppression: None / 10 Hz / 50 Hz / 60 Hz / 400 Hz

Measuring range: deactivated / 0 ... 10 V / 1 ... 5 V / ± 10 V / ± 5 V / ± 2.5 V

Limit value alarms enabled: ON / OFF

Upper / lower limit: 16-bit analog value (± 27648)

Technical specifications

Order no.	600-252-7BB01
Name	AI 2 x U ± 10 V, 0–10 V, 1–5 V, Iso., 16-bit
Module ID / module type	5210 _{dec.} / 0x0202
Number of inputs	2
Electrically isolated from backplane bus	Yes
Channels electrically isolated from each other	Yes
Current draw	
External	Not needed
Internal	Max. 140 mA
Power dissipation	Max. 1 W
Measuring ranges / load resistance	0 ... 10 V / 10 Mohms 1 ... 5 V / 10 Mohms ± 10 V / 10 Mohms ± 5 V / 10 Mohms ± 2.5 V / 10 Mohms
Measurement resolution	15 bits + sign
Measuring method	Integration
Interference frequency suppression	None / 10 Hz / 50 Hz / 60 Hz / 400 Hz
Refresh rate / conversion rate	<i>Depends on the interference frequency suppression setting being used:</i> None: 2 ms 400 Hz: 8 ms 60 Hz: 51 ms 50 Hz: 60 ms 10 Hz: 160 ms
Diagnoses	Upper measuring limit exceeded (overflow) Lower measuring limit fallen below (underflow) Wire break (<i>for 1–5 V only</i>) Parameter assignment error
Process alarms	Upper and lower limit per channel
Error limits	
Operational error limit	$\pm 0.2\%$ within the entire temperature range, relative to the nominal range
Basic error limit	$\pm 0.1\%$, operational error limit at 25 °C, relative to the nominal range
Temperature error	$\pm 0.005\%/K$, relative to the nominal range
Linearity error	$\pm 0.05\%/K$, relative to the nominal range
Repeating accuracy in steady state at 25 °C	$\pm 0.05\%/K$, relative to the nominal range
Parameter configuration length	13 bytes
General error indicator	Red LED
Weight	Approx. 70 g
Certification	UL 508

6.1.9. 600-252-7BD01, AI 4 x U, ±10 V, 0-10 V, 1-5 V, Iso., 16-bit

Characteristics

- 4 analog inputs for measuring voltage
- Channels electrically isolated from each other and from the backplane bus
- 4 process input words
- Measuring ranges 0 ... 10 V, 1 ... 5 V, ±10 V, ±5 V, ±2.5 V, individually configurable for each channel
- Measurement resolution: up to 15 bits + sign
- Diagnostic messages
- Red/green bi-color LEDs (one for each channel) indicate the channels' states
- Wire break detection (for 1–5 V)
- Limit value alarms for each channel
- A bi-color LED (blue/red) indicates the module's operating status and any malfunctions

Pin assignment

Connection	I/O
1	AI0 +
2	AI0 -
3	AI1 +
4	AI1 -
5	AI2 +
6	AI2 -
7	AI3 +
8	AI3 -
9	n.c.
10	AUX

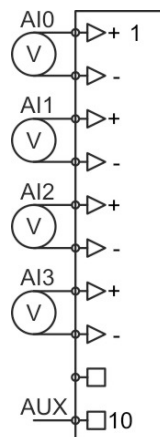

Channel LED signals:

Flashing red light = Parameter assignment error on channel

Solid red light = Reading overflow/underflow or wire break

Flashing green light = Reading within overdrive range

Solid green light = Channel configured, normal reading

Off = Channel disabled or module not yet configured

Parameters for the module

Diagnostic alarm: ON / OFF

Overflow / underflow diagnosis: ON / OFF

Format of values: Simatic S7 / Simatic S5 / INT16

Parameters for each channel

Wire break detection (*for 1-5V only*): ON / OFF

Interference frequency suppression: None / 10 Hz / 50 Hz / 60 Hz / 400 Hz

Measuring range: deactivated / 0 ... 10 V / 1 ... 5 V / ± 10 V / ± 5 V / ± 2.5 V

Limit value alarms enabled: ON / OFF

Upper / lower limit: 16-bit analog value (± 27648)

Technical specifications

Order no.	600-252-7BD01
Name	AI 4 x U ± 10 V, 0–10 V, 1–5 V, Iso., 16-bit
Module ID / module type	5410 _{dec.} / 0x0204
Number of inputs	4
Electrically isolated from backplane bus	Yes
Channels electrically isolated from each other	Yes
Current draw	
External	Not needed
Internal	Max. 140 mA
Power dissipation	Max. 1 W
Measuring ranges / load resistance	0 ... 10 V / 10 Mohms 1 ... 5 V / 10 Mohms ± 10 V / 10 Mohms ± 5 V / 10 Mohms ± 2.5 V / 10 Mohms
Measurement resolution	15 bits + sign
Measuring method	Integration
Interference frequency suppression	None / 10 Hz / 50 Hz / 60 Hz / 400 Hz
Refresh rate / conversion rate	<i>Depends on the interference frequency suppression setting being used:</i> None: 2.5 ms 400 Hz: 8 ms 60 Hz: 51 ms 50 Hz: 60 ms 10 Hz: 160 ms
Diagnoses	Upper measuring limit exceeded (overflow) Lower measuring limit fallen below (underflow) Wire break (<i>for 1-5 V only</i>) Configuration error
Process alarms	Upper and lower limit per channel
Error limits	
Operational error limit	$\pm 0.2\%$ within the entire temperature range, relative to the nominal range
Basic error limit	$\pm 0.1\%$, operational error limit at 25 °C, relative to the nominal range
Temperature error	$\pm 0.005\%/K$, relative to the nominal range
Linearity error	$\pm 0.05\%/K$, relative to the nominal range
Repeating accuracy in steady state at 25 °C	$\pm 0.05\%/K$, relative to the nominal range
Parameter configuration length	23 bytes
General error indicator	Red LED
Weight	Approx. 80 g
Certification	UL 508

6.1.10. 600-252-7BH21, AI 8 x U, ±10 V, 0–10 V, 1–5 V, Iso., 16-bit

Characteristics

- 8 analog inputs for measuring voltage
- Channels electrically isolated from each other and from the backplane bus
- 8 process input words
- Measuring ranges 0 ... 10 V, 1 ... 5 V, ±10 V, ±5 V, ±2.5 V, individually configurable for each channel
- Measurement resolution: up to 15 bits + sign
- Diagnostic messages
- Red/green bi-color LEDs (one for each channel) indicate the channels' states
- Wire break detection (for 1-5 V)
- Limit value alarms for each channel
- A bi-color LED (blue/red) indicates the module's operating status and any malfunctions

Pin assignment

Connection	I/O	Connection	I/O
1	AI0 +	11	AI4 +
2	AI0 -	12	AI4 -
3	AI1 +	13	AI5 +
4	AI1 -	14	AI5 -
5	AI2 +	15	AI6 +
6	AI2 -	16	AI6 -
7	AI3 +	17	AI7 +
8	AI3 -	18	AI7 -
9	n.c.	19	n.c.
10	AUX	20	AUX

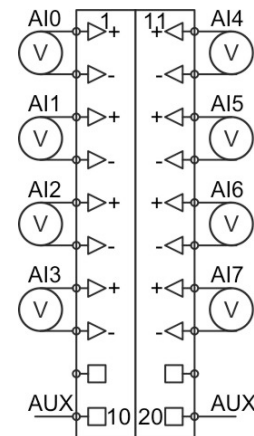

Channel LED signals:

Flashing red light = Parameter assignment error on channel

Solid red light = Reading overflow/underflow or wire break

Flashing green light = Reading within overdrive range

Solid green light = Channel configured, normal reading

Off = Channel disabled or module not yet configured

Parameters for the module

Diagnostic alarm: ON / OFF

Overflow / underflow diagnosis: ON / OFF

Format of values: Simatic S7 / Simatic S5 / INT16

Parameters for each channel

Wire break detection (*for 1-5V only*): ON / OFF

Interference frequency suppression: None / 10 Hz / 50 Hz / 60 Hz / 400 Hz

Measuring range: deactivated / 0 ... 10 V / 1 ... 5 V / ± 10 V / ± 5 V / ± 2.5 V

Limit value alarms enabled: ON / OFF

Upper / lower limit: 16-bit analog value (± 27648)

Technical specifications

Order no.	600-252-7BH21
Name	AI 8 x U ± 10 V, 0–10 V, 1–5 V, Iso., 16-bit
Module ID / module type	5810 _{dec.} / 0x0208
Number of inputs	8
Electrically isolated from backplane bus	Yes
Channels electrically isolated from each other	Yes
Current draw	
External	Not needed
Internal	Max. 140 mA
Power dissipation	Max. 1 W
Measuring ranges / load resistance	0 ... 10 V / 10 Mohms 1 ... 5 V / 10 Mohms ± 10 V / 10 Mohms ± 5 V / 10 Mohms ± 2.5 V / 10 Mohms
Measurement resolution	15 bits + sign
Measuring method	Integration
Interference frequency suppression	None / 10 Hz / 50 Hz / 60 Hz / 400 Hz
Refresh rate / conversion rate	<i>Depends on the interference frequency suppression setting being used:</i> None: 3 ms 400 Hz: 8 ms 60 Hz: 51 ms 50 Hz: 60 ms 10 Hz: 160 ms
Diagnoses	Upper measuring limit exceeded (overflow) Lower measuring limit fallen below (underflow) Wire break (<i>for 1-5 V only</i>) Configuration error
Process alarms	Upper and lower limit per channel
Error limits	
Operational error limit	$\pm 0.2\%$ within the entire temperature range, relative to the nominal range
Basic error limit	$\pm 0.1\%$, operational error limit at 25 °C, relative to the nominal range
Temperature error	$\pm 0.005\%/K$, relative to the nominal range
Linearity error	$\pm 0.05\%/K$, relative to the nominal range
Repeating accuracy in steady state at 25 °C	$\pm 0.05\%/K$, relative to the nominal range
Parameter configuration length	44 bytes
General error indicator	Red LED
Weight	Approx. 110 g
Certification	UL 508

6.1.11. 600-252-4CB01, AI 2 x U, ±24 V, 0–24 V, 12-bit

Characteristics

- 2 analog inputs for measuring voltage, electrically isolated from the backplane bus
- 2 process input words
- Measuring ranges 0 ... 24 V, ±24 V, individually configurable for each channel
- Measurement resolution: up to 12 bits + sign
- Diagnostic messages
- Limit value alarms for each channel
- A bi-color LED (blue/red) indicates the module's operating status and any malfunctions

Pin assignment

Connection	I/O
1	AI0 +
2	AI0 -
3	AI1 +
4	AI1 -
5	L+, 24 VDC
6	L+, 24 VDC
7	L-, GND
8	L-, GND
9	Mana
10	AUX

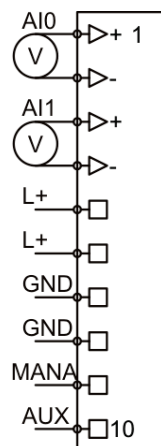

Parameters for the module

Diagnostic alarm: ON / OFF

Overflow / underflow diagnosis: ON / OFF

Representation values: Simatic S7 / Simatic S5

Parameters for each channel

Interference frequency suppression: None / 10 Hz / 50 Hz / 60 Hz / 400 Hz

Measuring range: deactivated / 0 ... 24 V / ±24 V

Limit value alarms enabled: ON / OFF

Upper / lower limit: 16-bit analog value (±27648)

Technical specifications

Order no.	600-252-4CB01
Name	AI 2 x U ± 24 V, 0–24 V, 12-bit
Module ID / module type	5220 _{dec.} / 0x0202
Number of inputs	2
Electrically isolated from backplane bus	Yes
Channels electrically isolated from each other	No
Current draw	
External	Not needed
Internal	Max. 95 mA
Power dissipation	Max. 0.7 W
Measuring ranges / load resistance	0 ... 24 V / 10 Mohms ± 24 V / 10 Mohms
Measurement resolution	12 bits + sign
Measuring method	Integration
Interference frequency suppression	None / 10 Hz / 50 Hz / 60 Hz / 400 Hz
Refresh rate / conversion rate	Number of active channels x conversion time + 16 ms for wire break detection for each channel when activated <i>The conversion time depends on the interference frequency suppression:</i> None: 8 ms 400 Hz: 45 ms 60 Hz: 109 ms 50 Hz: 128 ms 10 Hz: 342 ms
Diagnoses	Upper measuring limit exceeded (overflow) Lower measuring limit fallen below (underflow) Parameter assignment error
Process alarms	Upper and lower limit per channel
Error limits	
Operational error limit	$\pm 0.5\%$ within the entire temperature range, relative to the nominal range
Basic error limit	$\pm 0.3\%$, operational error limit at 25 °C, relative to the nominal range
Temperature error	$\pm 0.005\%/K$, relative to the nominal range
Linearity error	$\pm 0.05\%/K$, relative to the nominal range
Repeating accuracy in steady state at 25 °C	$\pm 0.05\%/K$, relative to the nominal range
Parameter configuration length	12 bytes
General error indicator	Red LED
Weight	Approx. 70 g
Certification	UL 508

6.1.12. 600-252-4CD01, AI 4 x U, ±24 V, 0–24 V, 12-bit

Characteristics

- 4 analog inputs for measuring voltage, electrically isolated from the backplane bus
- 4 process input words
- Measuring ranges 0 ... 24 V, ±24 V, individually configurable for each channel
- Measurement resolution: up to 12 bits + sign
- Diagnostic messages
- Limit value alarms for each channel
- A bi-color LED (blue/red) indicates the module's operating status and any malfunctions

Pin assignment

Connection	I/O
1	AI0 +
2	AI0 -
3	AI1 +
4	AI1 -
5	AI2 +
6	AI2 -
7	AI3 +
8	AI3 -
9	Mana
10	AUX

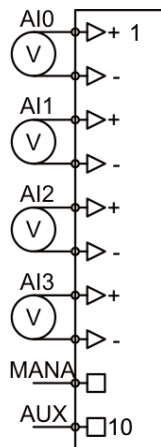

Parameters for the module

Diagnostic alarm: ON / OFF

Overflow / underflow diagnosis: ON / OFF

Representation values: Simatic S7 / Simatic S5

Parameters for each channel

Interference frequency suppression: None / 10 Hz / 50 Hz / 60 Hz / 400 Hz

Measuring range: deactivated / 0 ... 24 V / ±24 V

Limit value alarms enabled: ON / OFF

Upper / lower limit: 16-bit analog value (±27648)

Technical specifications

Order no.	600-252-4CD01
Name	AI 4 x U ± 24 V, 0–24 V, 12-bit
Module ID / module type	5440 _{dec.} / 0x0204
Number of inputs	4
Electrically isolated from backplane bus	Yes
Channels electrically isolated from each other	No
Current draw	
External	Not needed
Internal	Max. 95 mA
Power dissipation	Max. 0.7 W
Measuring ranges / load resistance	0 ... 24 V / 10 Mohms ± 24 V / 10 Mohms
Measurement resolution	12 bits + sign
Measuring method	Integration
Interference frequency suppression	None / 10 Hz / 50 Hz / 60 Hz / 400 Hz
Refresh rate / conversion rate	Number of active channels x conversion time + 16 ms for wire break detection for each channel when activated <i>The conversion time depends on the interference frequency suppression:</i> None: 8 ms 400 Hz: 45 ms 60 Hz: 109 ms 50 Hz: 128 ms 10 Hz: 342 ms
Diagnoses	Upper measuring limit exceeded (overflow) Lower measuring limit fallen below (underflow) Parameter assignment error
Process alarms	Upper and lower limit per channel
Error limits	
Operational error limit	$\pm 0.5\%$ within the entire temperature range, relative to the nominal range
Basic error limit	$\pm 0.3\%$, operational error limit at 25 °C, relative to the nominal range
Temperature error	$\pm 0.005\%/K$, relative to the nominal range
Linearity error	$\pm 0.05\%/K$, relative to the nominal range
Repeating accuracy in steady state at 25 °C	$\pm 0.05\%/K$, relative to the nominal range
Parameter configuration length	22 bytes
General error indicator	Red LED
Weight	Approx. 70 g
Certification	UL 508

6.1.13. 600-252-7DD01, AI 4 x U, ±100 V, 0-100 V, Iso., 16 bit

Characteristics

- 4 analog inputs for measuring voltage
- Channels electrically isolated from each other and from the backplane bus
- 4 process input words
- Measuring ranges 0 ... 100 V, ±100 V, individually configurable for each channel
- Measurement resolution: up to 15 bits + sign
- Diagnostic messages
- Red/green bi-color LEDs (one for each channel) indicate the channels' states
- Limit value alarms for each channel
- A bi-color LED (blue/red) indicates the module's operating status and any malfunctions

Pin assignment

Connection	I/O
1	AI0 +
2	AI0 -
3	AI1 +
4	AI1 -
5	AI2 +
6	AI2 -
7	AI3 +
8	AI3 -
9	n.c.
10	AUX

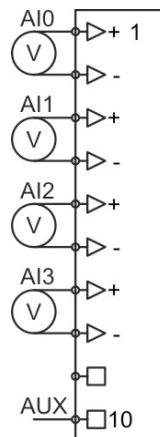

Channel LED signals:

Flashing red light = Parameter assignment error on channel

Solid red light = Reading overflow/underflow or wire break

Flashing green light = Reading within overdrive range

Solid green light = Channel configured, normal reading

Off = Channel disabled or module not yet configured

Parameters for the module

Diagnostic alarm: ON / OFF

Overflow / underflow diagnosis: ON / OFF

Format of values: Simatic S7 / Simatic S5 / INT16

Parameters for each channel

Interference frequency suppression: None / 10 Hz / 50 Hz / 60 Hz / 400 Hz

Measuring range: deactivated / 0 ... 100 V / ± 100 V

Limit value alarms enabled: ON / OFF

Upper / lower limit: 16-bit analog value (± 27648)

Technical specifications

Order no.	600-252-7DD01
Name	AI 4 x U ± 100 V, 0-100 V, Iso., 16-bit
Module ID / module type	5411 _{dec.} / 0x0204
Number of inputs	4
Electrically isolated from backplane bus	Yes
Channels electrically isolated from each other	Yes
Current draw	
External	Not needed
Internal	Max. 140 mA
Power dissipation	Max. 1 W
Measuring ranges / load resistance	0 ... 100 V / 2 Mohms ± 100 V / 2 Mohms
Measurement resolution	15 bits + sign
Measuring method	Integration
Interference frequency suppression	None / 10 Hz / 50 Hz / 60 Hz / 400 Hz
Refresh rate / conversion rate	<i>Depends on the interference frequency suppression setting being used:</i> None: 2.5 ms 400 Hz: 8 ms 60 Hz: 51 ms 50 Hz: 60 ms 10 Hz: 160 ms
Diagnoses	Upper measuring limit exceeded (overflow) Lower measuring limit fallen below (underflow) Parameter assignment error
Process alarms	Upper and lower limit per channel
Error limits	
Operational error limit	$\pm 0.2\%$ within the entire temperature range, relative to the nominal range
Basic error limit	$\pm 0.1\%$, operational error limit at 25 °C, relative to the nominal range
Temperature error	$\pm 0.005\%/K$, relative to the nominal range
Linearity error	$\pm 0.05\%/K$, relative to the nominal range
Repeating accuracy in steady state at 25 °C	$\pm 0.05\%/K$, relative to the nominal range
Parameter configuration length	23 bytes
General error indicator	Red LED
Weight	Approx. 80 g
Certification	UL 508

6.1.14. 600-252-7DH21, AI 8 x U, ±100 V, 0-100 V, Iso., 16 bit

Characteristics

- 8 analog inputs for measuring voltage
- Channels electrically isolated from each other and from the backplane bus
- 8 process input words
- Measuring ranges 0 ... 100 V, ±100 V, individually configurable for each channel
- Measurement resolution: up to 15 bits + sign
- Diagnostic messages
- Red/green bi-color LEDs (one for each channel) indicate the channels' states
- Limit value alarms for each channel
- A bi-color LED (blue/red) indicates the module's operating status and any malfunctions

Pin assignment

Connection	I/O	Connection	I/O
1	AI0 +	11	AI4 +
2	AI0 -	12	AI4 -
3	AI1 +	13	AI5 +
4	AI1 -	14	AI5 -
5	AI2 +	15	AI6 +
6	AI2 -	16	AI6 -
7	AI3 +	17	AI7 +
8	AI3 -	18	AI7 -
9	n.c.	19	n.c.
10	AUX	20	AUX

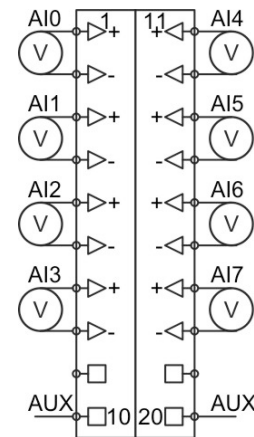

Channel LED signals:

Flashing red light = Parameter assignment error on channel

Solid red light = Reading overflow/underflow or wire break

Flashing green light = Reading within overdrive range

Solid green light = Channel configured, normal reading

Off = Channel disabled or module not yet configured

Parameters for the module

Diagnostic alarm: ON / OFF

Overflow / underflow diagnosis: ON / OFF

Format of values: Simatic S7 / Simatic S5 / INT16

Parameters for each channel

Interference frequency suppression: None / 10 Hz / 50 Hz / 60 Hz / 400 Hz

Measuring range: deactivated / 0 ... 100 V / ±100 V

Limit value alarms enabled: ON / OFF

Upper / lower limit: 16-bit analog value (± 27648)

Technical specifications

Order no.	600-252-7DH21
Name	AI 8 x U ± 100 V, 0-100 V, Iso., 16-bit
Module ID / module type	5811 _{dec.} / 0x0208
Number of inputs	8
Electrically isolated from backplane bus	Yes
Channels electrically isolated from each other	Yes
Current draw	
External	Not needed
Internal	Max. 140 mA
Power dissipation	Max. 1 W
Measuring ranges / load resistance	0 ... 10 V / 2 Mohms ± 100 V / 2 Mohms
Measurement resolution	15 bits + sign
Measuring method	Integration
Interference frequency suppression	None / 10 Hz / 50 Hz / 60 Hz / 400 Hz
Refresh rate / conversion rate	<i>Depends on the interference frequency suppression setting being used:</i> None: 3 ms 400 Hz: 8 ms 60 Hz: 51 ms 50 Hz: 60 ms 10 Hz: 160 ms
Diagnoses	Upper measuring limit exceeded (overflow) Lower measuring limit fallen below (underflow) Parameter assignment error
Process alarms	Upper and lower limit per channel
Error limits	
Operational error limit	$\pm 0.2\%$ within the entire temperature range, relative to the nominal range
Basic error limit	$\pm 0.1\%$, operational error limit at 25 °C, relative to the nominal range
Temperature error	$\pm 0.005\%/K$, relative to the nominal range
Linearity error	$\pm 0.05\%/K$, relative to the nominal range
Repeating accuracy in steady state at 25 °C	$\pm 0.05\%/K$, relative to the nominal range
Parameter configuration length	44 bytes
General error indicator	Red LED
Weight	Approx. 110 g
Certification	UL 508

6.1.15. 600-253-4AB01, AI 1/2 x R, RTD, 16-bit, 2/3/4-wire

Characteristics

- 1/2 inputs for measuring resistance, electrically isolated from the backplane bus
- 2 process input words
- Measuring ranges 150 ohms, 300 ohms, 600 ohms, 3000 ohms, 6000 ohms, PT 100, PT 1000, Ni 100, Ni 1000, LGNi 1000, PT 100 climate (*as of FW V.1.06*), PT 1000 climate (*as of FW V1.06*), can be configured individually for each channel
- Can accommodate 2/3/4-wire sensors
- Measurement resolution: up to 15 bits + sign
- Diagnostic messages
- Wire break detection
- Limit value alarms for each channel
- A bi-color LED (blue/red) indicates the module's operating status and any malfunctions

Pin assignment

Connection	I/O
1	AI0 +
2	AI0 -
3	AI1 +
4	AI1 -
5	L+, 24 VDC
6	L+, 24 VDC
7	L-, GND
8	L-, GND
9	Mana
10	AUX

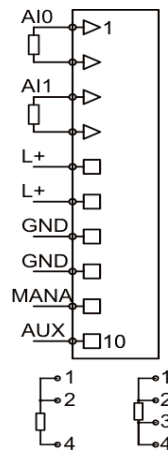

Parameters for the module

Diagnostic alarm: ON / OFF

Overflow / underflow diagnosis: ON / OFF

Representation values: Simatic S7 / Simatic S5

Temperature unit: Celsius x 10 / Fahrenheit x 10 / Kelvin x 10

Parameters for each channel

Wire break detection: ON / OFF

Interference frequency suppression: None / 10 Hz / 50 Hz / 60 Hz / 400 Hz

Measuring ranges: 150 ohms / 300 ohms / 600 ohms / 3000 ohms / 6000 ohms / PT100 / PT1000 / Ni100 / Ni1000 / LGNi1000 / PT 100 climate / PT 1000 climate

Sensor connection: disabled / 2-wire / 3-wire (*channel 0 only*) / 4-wire (*channel 0 only*)

Limit value alarms enabled: ON / OFF

Upper / lower limit: 16-bit analog value (± 27648)

Technical specifications

Order no.	600-253-4AB01
Name	AI 1/2 x R, RTD, 16-bit, 2/3/4-wire
Module ID / module type	6200 _{dec.} / 0x0202
Number of inputs	1 / 2
Electrically isolated from backplane bus	Yes
Channels electrically isolated from each other	No
Current draw	
External	Not needed
Internal	Max. 140 mA
Power dissipation	Max. 1.0 W
Measuring ranges	150 ohms / 300 ohms / 600 ohms / 3000 ohms / 6000 ohms PT 100 / PT 1000 Ni 100 / Ni 1000 LGNi 1000 PT 100 climate / PT 1000 climate (<i>as of FW V1.06</i>)
Measurement resolution	15 bits + sign
Measuring method	Integration
Interference frequency suppression	None / 10 Hz / 50 Hz / 60 Hz / 400 Hz
Refresh rate / conversion rate	Number of active channels x conversion time + 16 ms for wire break detection for each channel when activated <i>The conversion time depends on the interference frequency suppression:</i> None: 8 ms 400 Hz: 45 ms 60 Hz: 109 ms 50 Hz: 128 ms 10 Hz: 342 ms
Diagnoses	Upper measuring limit exceeded (overflow) Lower measuring limit fallen below (underflow) Wire break Parameter assignment error
Process alarms	Upper and lower limit per channel
Error limits	
Operational error limit	±0.5% within the entire temperature range, relative to the nominal range
Basic error limit	±0.3%, operational error limit at 25 °C, relative to the nominal range
Temperature error	±0.005%/K, relative to the nominal range
Linearity error	±0.05%/K, relative to the nominal range
Repeating accuracy in steady state at 25 °C	±0.05%/K, relative to the nominal range
Parameter configuration length	14 bytes
General error indicator	Red LED
Weight	Approx. 70 g
Certification	UL 508

6.1.16. 600-253-4AD01, AI 2/4 x R, RTD, 16-bit, 2/3/4-wire

Characteristics

- 2/4 inputs for measuring resistance, electrically isolated from the backplane bus
- 4 process input words
- Measuring ranges 150 ohms, 300 ohms, 600 ohms, 3000 ohms, 6000 ohms, PT 100, PT 1000, Ni 100, Ni 1000, LGNi 1000, PT 100 climate (*as of FW V.1.06*), PT 1000 climate (*as of FW V1.06*), can be configured individually for each channel
- Can accommodate 2/3/4-wire sensors
- Measurement resolution: up to 15 bits + sign
- Diagnostic messages
- Wire break detection
- Limit value alarms for each channel
- A bi-color LED (blue/red) indicates the module's operating status and any malfunctions

Pin assignment

Connection	I/O
1	AI0 +
2	AI0 -
3	AI1 +
4	AI1 -
5	AI2 +
6	AI2 -
7	AI3 +
8	AI3 -
9	Mana
10	AUX

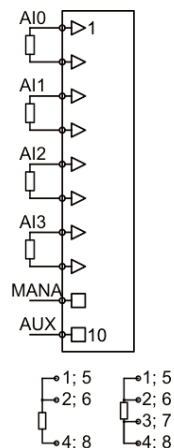

Parameters for the module

Diagnostic alarm: ON / OFF

Overflow / underflow diagnosis: ON / OFF

Representation values: Simatic S7 / Simatic S5

Temperature unit: Celsius x 10 / Fahrenheit x 10 / Kelvin x 10

Parameters for each channel

Wire break detection: ON / OFF

Interference frequency suppression: None / 10 Hz / 50 Hz / 60 Hz / 400 Hz

Measuring ranges: 150 ohms / 300 ohms / 600 ohms / 3000 ohms / 6000 ohms / PT100 / PT1000 / Ni100 / Ni1000 / LGNi1000 / PT 100 climate / PT 1000 climate

Sensor connection: / 2-wire / 3-wire (*channels 0&2 only*) / 4-wire (*channels 0&2 only*)

Limit value alarms enabled: ON / OFF

Upper / lower limit: 16-bit analog value (± 27648)

Technical specifications

Order no.	600-253-4AD01
Name	AI 2/4 x R, RTD, 16-bit, 2/3/4-wire
Module ID / module type	6400 _{dec.} / 0x0204
Number of inputs	2 / 4
Electrically isolated from backplane bus	Yes
Channels electrically isolated from each other	No
Current draw	
External	Not needed
Internal	Max. 140 mA
Power dissipation	Max. 1.0 W
Measuring ranges	150 ohms / 300 ohms / 600 ohms / 3000 ohms / 6000 ohms PT 100 / PT 1000 Ni 100 / Ni 1000 LGNi 1000 PT 100 climate / PT 1000 climate (<i>as of FW V1.06</i>)
Measurement resolution	15 bits + sign
Measuring method	Integration
Interference frequency suppression	None / 10 Hz / 50 Hz / 60 Hz / 400 Hz
Refresh rate / conversion rate	Number of active channels x conversion time + 16 ms for wire break detection for each channel when activated <i>The conversion time depends on the interference frequency suppression:</i> None: 8 ms 400 Hz: 45 ms 60 Hz: 109 ms 50 Hz: 128 ms 10 Hz: 342 ms
Diagnoses	Upper measuring limit exceeded (overflow) Lower measuring limit fallen below (underflow) Wire break Parameter assignment error
Process alarms	Upper and lower limit per channel
Error limits	
Operational error limit	±0.5% within the entire temperature range, relative to the nominal range
Basic error limit	±0.3%, operational error limit at 25 °C, relative to the nominal range
Temperature error	±0.005%/K, relative to the nominal range
Linearity error	±0.05%/K, relative to the nominal range
Repeating accuracy in steady state at 25 °C	±0.05%/K, relative to the nominal range
Parameter configuration length	26 bytes
General error indicator	Red LED
Weight	Approx. 70 g
Certification	UL 508

6.1.17. 600-254-4AB01, AI 2 x TC, 16-bit

Characteristics

- 2 inputs, electrically isolated from the backplane bus
- 2 process input words
- 2 process output words (for temperature compensation)
- Measuring range: ± 80 mV
- Supported thermocouples: E, J, K, N, R, S, T, B, C, L
- Measurement resolution: up to 15 bits + sign
- External or internal temperature compensation
- Diagnostic messages
- Limit value alarms for each channel
- A bi-color LED (blue/red) indicates the module's operating status and any malfunctions

Pin assignment

Connection	I/O
1	AI0 +
2	AI0 -
3	AI1 +
4	AI1 -
5	L+, 24 VDC
6	L+, 24 VDC
7	L-, GND
8	L-, GND
9	Mana
10	AUX

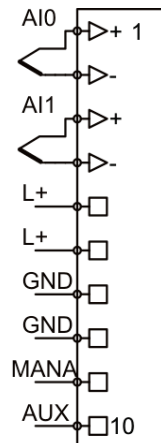

Input area (2 values, 4 bytes)

Value 1	Byte 0	Analog value for channel 0
	Byte 1	
Value 2	Byte 2	Analog value for channel 1
	Byte 3	

Output area (2 values, 4 bytes)

Value 1	Byte 0	External temperature compensation channel 0
	Byte 1	
Value 2	Byte 2	External temperature compensation channel 1
	Byte 3	

Parameters for the module

Diagnostic alarm: ON / OFF

Overflow / underflow diagnosis: ON / OFF

Representation values: Simatic S7 / Simatic S5 (for ± 80 mV only)

Temperature unit: Celsius x 10 / Fahrenheit x 10 / Kelvin x 10

Parameters for each channel

Wire break detection: ON / OFF

Interference frequency suppression: None / 10 Hz / 50 Hz / 60 Hz / 400 Hz

Measuring ranges: ±80 mV

Thermocouples: E / J / K / N / R / S / T / B / C / L

Temperature compensation: internal / external / process data-based

Limit value alarms enabled: ON / OFF

Upper / lower limit: 16-bit analog value (±27648)

Technical specifications

Order no.	600-254-4AB01
Name	AI 2 x TC, 16-bit
Module ID / module type	7200 _{dec.} / 0x0222
Number of inputs	2
Electrically isolated from backplane bus	Yes
Channels electrically isolated from each other	No
Current draw	
External	Not needed
Internal	Max. 95 mA
Power dissipation	Max. 0.7 W
Measuring ranges	±80 mV
Thermocouples	E (-270 °C ... 990 °C) J (-210 °C ... 1200 °C) K (-270 °C ... 1380 °C) N (-270 °C ... 1320 °C) R (-50 °C ... 1775 °C) S (-50 °C ... 1775 °C) T (-270 °C ... 405 °C) B (0 °C ... 1800 °C) C (0 °C ... 2320 °C) L (0 °C ... 900 °C)
Resolution	15 bits + sign
Measuring method	Integration
Interference frequency suppression	None / 10 Hz / 50 Hz / 60 Hz / 400 Hz
Refresh rate / conversion rate	Number of active channels x conversion time + 16 ms for wire break detection for each channel when activated <i>The conversion time will depend on the interference frequency suppression setting being used:</i> None: 8 ms 400 Hz: 45 ms 60 Hz: 109 ms 50 Hz: 128 ms 10 Hz: 342 ms
Diagnoses	Upper measuring limit exceeded (overflow) Lower measuring limit fallen below (underflow) Parameter assignment error
Process alarms	Upper and lower limit per channel

Error limits	
Operational error limit	$\pm 0.5\%$ within the entire temperature range, relative to the nominal range
Basic error limit	$\pm 0.3\%$, operational error limit at 25 °C, relative to the nominal range
Temperature error	$\pm 0.005\%/K$, relative to the nominal range
Linearity error	$\pm 0.05\%/K$, relative to the nominal range
Repeating accuracy in steady state at 25 °C	$\pm 0.05\%/K$, relative to the nominal range
Parameter configuration length	26 bytes
General error indicator	Red LED
Weight	Approx. 70 g
Certification	UL 508

6.1.18. 600-254-4AD01, AI 4 x TC, 16-bit

Characteristics

- 4 inputs, electrically isolated from the backplane bus
- 4 process input words
- 4 process output words (for temperature compensation)
- Measuring range: ± 80 mV
- Supported thermocouples: E, J, K, N, R, S, T, B, C, L
- Measurement resolution: up to 15 bits + sign
- External or internal temperature compensation
- Diagnostic messages
- Limit value alarms for each channel
- A bi-color LED (blue/red) indicates the module's operating status and any malfunctions

Pin assignment

Connection	I/O
1	AI0 +
2	AI0 -
3	AI1 +
4	AI1 -
5	AI2 +
6	AI2 -
7	AI3 +
8	AI3 -
9	Mana
10	AUX

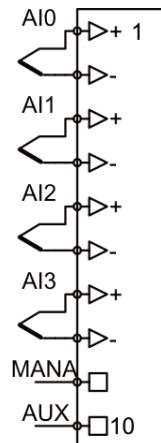

Input area (4 values, 8 bytes)

Value 1	Byte 0	Analog value for channel 0
	Byte 1	
Value 2	Byte 2	Analog value for channel 1
	Byte 3	
Value 3	Byte 4	Analog value for channel 2
	Byte 5	
Value 4	Byte 6	Analog value for channel 3
	Byte 7	

Output area (4 values, 8 bytes)

Value 1	Byte 0	External temperature compensation channel 0
	Byte 1	
Value 2	Byte 2	External temperature compensation channel 1
	Byte 3	
Value 3	Byte 4	External temperature compensation channel 2
	Byte 5	
Value 4	Byte 6	External temperature compensation channel 3
	Byte 7	

Parameters for the module

Diagnostic alarm: ON / OFF

Overflow / underflow diagnosis: ON / OFF

Representation values: Simatic S7 / Simatic S5 (*for ±80 mV only*)

Temperature unit: Celsius x 10 / Fahrenheit x 10 / Kelvin x 10

Parameters for each channel

Wire break detection: ON / OFF

Interference frequency suppression: None / 10 Hz / 50 Hz / 60 Hz / 400 Hz

Measuring ranges: ±80 mV

Thermocouples: E / J / K / N / R / S / T / B / C / L

Temperature compensation: internal / external / process data-based

Limit value alarms enabled: ON / OFF

Upper / lower limit: 16-bit analog value (±27648)

Technical specifications

Order no.	600-254-4AD01
Name	AI 4 x TC, 16-bit
Module ID / module type	7400 _{dec.} / 0x0244
Number of inputs	4
Electrically isolated from backplane bus	Yes
Channels electrically isolated from each other	No
Current draw	
External	Not needed
Internal	Max. 95 mA
Power dissipation	Max. 0.7 W
Measuring ranges	±80mV
Thermocouples	E (-270 °C ... 990 °C) J (-210 °C ... 1200 °C) K (-270 °C ... 1380 °C) N (-270 °C ... 1320 °C) R (-50 °C ... 1775 °C) S (-50 °C ... 1775 °C) T (-270 °C ... 405 °C) B (0 °C ... 1800 °C) C (0 °C ... 2320 °C) L (0 °C ... 900 °C)
Resolution	15 bits + sign
Measuring method	Integration
Interference frequency suppression	None / 10 Hz / 50 Hz / 60 Hz / 400 Hz
Refresh rate / conversion rate	Number of active channels x conversion time + 16 ms for wire break detection for each channel when activated <i>The conversion time will depend on the interference frequency suppression setting being used:</i> None: 8 ms 400 Hz: 45 ms 60 Hz: 109 ms 50 Hz: 128 ms 10 Hz: 342 ms

Diagnoses	Upper measuring limit exceeded (overflow) Lower measuring limit fallen below (underflow) Parameter assignment error
Process alarms	Upper and lower limit per channel
Error limits	
Operational error limit	$\pm 0.5\%$ within the entire temperature range, relative to the nominal range
Basic error limit	$\pm 0.3\%$, operational error limit at 25 °C, relative to the nominal range
Temperature error	$\pm 0.005\%/K$, relative to the nominal range
Linearity error	$\pm 0.05\%/K$, relative to the nominal range
Repeating accuracy in steady state at 25 °C	$\pm 0.05\%/K$, relative to the nominal range
Parameter configuration length	26 bytes
General error indicator	Red LED
Weight	Approx. 70 g
Certification	UL 508

6.1.19. 600-254-4AB02, AI 2 x TC, Iso., 16-bit

Characteristics

- 2 inputs
- Channels electrically isolated from each other and from the backplane bus
- 2 process input words, 2 process output words (for temperature compensation)
- Measuring range: ± 80 mV
- Supported thermocouples: E, J, K, N, R, S, T, B, C, L
- Measurement resolution: 15 bits + sign
- External or internal temperature compensation
- Red/green bi-color LEDs (one for each channel) indicate the channels' states
- Wire break detection
- Diagnostic messages
- Limit value alarms for each channel
- A bi-color LED (blue/red) indicates the module's operating status and any malfunctions

Pin assignment

Connection	I/O
1	AI0 +
2	AI0 -
3	AI1 +
4	AI1 -
5	n.c.
6	n.c.
7	n.c.
8	n.c.
9	n.c.
10	AUX

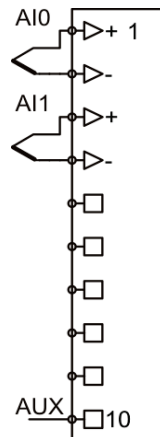

Channel LED signals:

Flashing red light = Parameter assignment error on channel

Solid red light = Reading overflow/underflow or wire break

Flashing green light = Reading within overdrive range

Solid green light = Channel configured, normal reading

Off = Channel disabled or module not yet configured

Input area (2 values, 4 bytes)

Value 1	Byte 0	Analog value for channel 0
	Byte 1	
Value 2	Byte 2	Analog value for channel 1
	Byte 3	

Output area (2 values, 4 bytes)

Value 1	Byte 0	External temperature compensation channel 0
	Byte 1	
Value 2	Byte 2	External temperature compensation channel 1
	Byte 3	

Parameters for the module

Diagnostic alarm: ON / OFF

Overflow / underflow diagnosis: ON / OFF

Representation values: Simatic S7 / Simatic S5 (*for ±80 mV only*)

Temperature unit: Celsius x 10 / Fahrenheit x 10 / Kelvin x 10

Parameters for each channel

Wire break detection: ON / OFF

Interference frequency suppression: None / 10 Hz / 50 Hz / 60 Hz / 400 Hz

Measuring ranges: ±80 mV

Thermocouples: E / J / K / N / R / S / T / B / C / L

Temperature compensation: internal / external / process data-based

Limit value alarms enabled: ON / OFF

Upper / lower limit: 16-bit analog value (±27648)

Technical specifications

Order no.	600-254-4AB02
Name	AI 2 x TC, Iso., 16-bit
Module ID / module type	7201 _{dec.} / 0x0222
Number of inputs	2
Electrically isolated from backplane bus	Yes
Channels electrically isolated from each other	Yes
Current draw	
External	Not needed
Internal	Max. 140 mA
Power dissipation	Max. 1 W
Measuring ranges	±80 mV
Thermocouples	E (-270 °C ... 990 °C) J (-210 °C ... 1200 °C) K (-270 °C ... 1380 °C) N (-270 °C ... 1320 °C) R (-50 °C ... 1775 °C) S (-50 °C ... 1775 °C) T (-270 °C ... 405 °C) B (0 °C ... 1800 °C) C (0 °C ... 2320 °C) L (0 °C ... 900 °C)

Measurement resolution	15 bits + sign
Measuring method	Integration
Interference frequency suppression	None / 10 Hz / 50 Hz / 60 Hz / 400 Hz
Refresh rate / conversion rate	<i>Depends on the interference frequency suppression setting being used:</i> None: 2 ms 400 Hz: 8 ms 60 Hz: 51 ms 50 Hz: 60 ms 10 Hz: 160 ms
Diagnoses	Upper measuring limit exceeded (overflow) Lower measuring limit fallen below (underflow) Wire break Parameter assignment error
Process alarms	Upper and lower limit per channel
Error limits	
Operational error limit	±0.5% within the entire temperature range, relative to the nominal range
Basic error limit	±0.3%, operational error limit at 25 °C, relative to the nominal range
Temperature error	±0.005%/K, relative to the nominal range
Linearity error	±0.05%/K, relative to the nominal range
Repeating accuracy in steady state at 25 °C	±0.05%/K, relative to the nominal range
Parameter configuration length	26 bytes
General error indicator	Red LED
Weight	Approx. 70 g
Certification	UL 508

6.1.20. 600-254-4AD02, AI 4 x TC, Iso., 16-bit

Characteristics

- 4 inputs
- Channels electrically isolated from each other and from the backplane bus
- 4 process input words, 4 process output words (for temperature compensation)
- Measuring range: ± 80 mV
- Supported thermocouples: E, J, K, N, R, S, T, B, C, L
- Measurement resolution: 15 bits + sign
- External or internal temperature compensation
- Red/green bi-color LEDs (one for each channel) indicate the channels' states
- Wire break detection
- Diagnostic messages
- Limit value alarms for each channel
- A bi-color LED (blue/red) indicates the module's operating status and any malfunctions

Pin assignment

Connection	I/O
1	AI0 +
2	AI0 -
3	AI1 +
4	AI1 -
5	AI2 +
6	AI2 -
7	AI3 +
8	AI3 -
9	n.c.
10	AUX

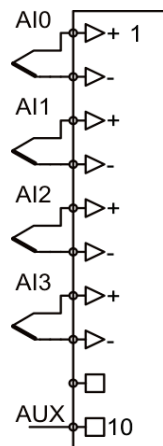

Channel LED signals:

Flashing red light = Parameter assignment error on channel

Solid red light = Reading overflow/underflow or wire break

Flashing green light = Reading within overdrive range

Solid green light = Channel configured, normal reading

Off = Channel disabled or module not yet configured

Input area (4 values, 8 bytes)

Value 1	Byte 0	Analog value for channel 0
	Byte 1	
Value 2	Byte 2	Analog value for channel 1
	Byte 3	
Value 3	Byte 4	Analog value for channel 2
	Byte 5	
Value 4	Byte 6	Analog value for channel 3
	Byte 7	

Output area (4 values, 8 bytes)

Value 1	Byte 0	External temperature compensation channel 0
	Byte 1	
Value 2	Byte 2	External temperature compensation channel 1
	Byte 3	
Value 3	Byte 4	External temperature compensation channel 2
	Byte 5	
Value 4	Byte 6	External temperature compensation channel 3
	Byte 7	

Parameters for the module

Diagnostic alarm: ON / OFF

Overflow / underflow diagnosis: ON / OFF

Representation values: Simatic S7 / Simatic S5 (*for ±80 mV only*)

Temperature unit: Celsius x 10 / Fahrenheit x 10 / Kelvin x 10

Parameters for each channel

Wire break detection: ON / OFF

Interference frequency suppression: None / 10 Hz / 50 Hz / 60 Hz / 400 Hz

Measuring ranges: ±80 mV

Thermocouples: E / J / K / N / R / S / T / B / C / L

Temperature compensation: internal / external / process data-based

Limit value alarms enabled: ON / OFF

Upper / lower limit: 16-bit analog value (±27648)

Technical specifications

Order no.	600-254-4AD02
Name	AI 4 x TC, Iso., 16-bit
Module ID / module type	7401 _{dec.} / 0x0244
Number of inputs	4
Electrically isolated from backplane bus	Yes
Channels electrically isolated from each other	Yes
Current draw	
External	Not needed
Internal	Max. 95 mA
Power dissipation	Max. 0.7 W
Measuring ranges	±80mV

Thermocouples	E (-270 °C ... 990 °C) J (-210 °C ... 1200 °C) K (-270 °C ... 1380 °C) N (-270 °C ... 1320 °C) R (-50 °C ... 1775 °C) S (-50 °C ... 1775 °C) T (-270 °C ... 405 °C) B (0 °C ... 1800 °C) C (0 °C ... 2320 °C) L (0 °C ... 900 °C)
Measurement resolution	15 bits + sign
Measuring method	Integration
Interference frequency suppression	None / 10 Hz / 50 Hz / 60 Hz / 400 Hz
Refresh rate / conversion rate	<i>Depends on the interference frequency suppression setting being used:</i> None: 2.5 ms 400 Hz: 8 ms 60 Hz: 51 ms 50 Hz: 60 ms 10 Hz: 160 ms
Diagnoses	Upper measuring limit exceeded (overflow) Lower measuring limit fallen below (underflow) Wire break Parameter assignment error
Process alarms	Upper and lower limit per channel
Error limits	
Operational error limit	±0.5% within the entire temperature range, relative to the nominal range
Basic error limit	±0.3%, operational error limit at 25 °C, relative to the nominal range
Temperature error	±0.005%/K, relative to the nominal range
Linearity error	±0.05%/K, relative to the nominal range
Repeating accuracy in steady state at 25 °C	±0.05%/K, relative to the nominal range
Parameter configuration length	26 bytes
General error indicator	Red LED
Weight	Approx. 70 g
Certification	UL 508

6.1.21. 600-254-4AH22, AI 8 x TC, Iso., 16-bit

Characteristics

- 8 inputs
- Channels electrically isolated from each other and from the backplane bus
- 8 process input words, 8 process output words (for temperature compensation)
- Measuring range: ± 80 mV
- Supported thermocouples: E, J, K, N, R, S, T, B, C, L
- Measurement resolution: 15 bits + sign
- External or internal temperature compensation
- Red/green bi-color LEDs (one for each channel) indicate the channels' states
- Wire break detection
- Diagnostic messages
- Limit value alarms for each channel
- A bi-color LED (blue/red) indicates the module's operating status and any malfunctions

Pin assignment

Connection	I/O	Connection	I/O
1	AI0 +	11	AI4 +
2	AI0 -	12	AI4 -
3	AI1 +	13	AI5 +
4	AI1 -	14	AI5 -
5	AI2 +	15	AI6 +
6	AI2 -	16	AI6 -
7	AI3 +	17	AI7 +
8	AI3 -	18	AI7 -
9	n.c.	19	n.c.
10	AUX	20	AUX

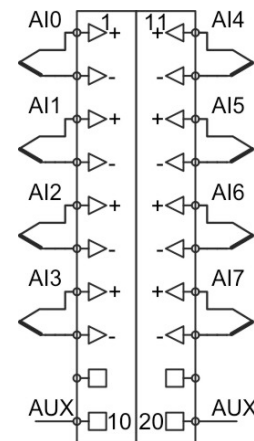

Channel LED signals:

Flashing red light = Parameter assignment error on channel

Solid red light = Reading overflow/underflow or wire break

Flashing green light = Reading within overdrive range

Solid green light = Channel configured, normal reading

Off = Channel disabled or module not yet configured

Input area (16 bytes)

Value 1	Byte 0	Analog value for channel 0
	Byte 1	
Value 2	Byte 2	Analog value for channel 1
	Byte 3	
Value 3	Byte 4	Analog value for channel 2
	Byte 5	
Value 4	Byte 6	Analog value for channel 3
	Byte 7	
Value 5	Byte 8	Analog value for channel 4
	Byte 9	
Value 6	Byte 10	Analog value for channel 5
	Byte 11	
Value 7	Byte 12	Analog value for channel 6
	Byte 13	
Value 8	Byte 14	Analog value for channel 7
	Byte 15	

Output area (16 byte)

Value 1	Byte 0	External temperature compensation channel 0
	Byte 1	
Value 2	Byte 2	External temperature compensation channel 1
	Byte 3	
Value 3	Byte 4	External temperature compensation channel 2
	Byte 5	
Value 4	Byte 6	External temperature compensation channel 3
	Byte 7	
Value 5	Byte 8	External temperature compensation channel 4
	Byte 9	
Value 6	Byte 10	External temperature compensation channel 5
	Byte 11	
Value 7	Byte 12	External temperature compensation channel 6
	Byte 13	
Value 8	Byte 14	External temperature compensation channel 7
	Byte 15	

Parameters for the module

Diagnostic alarm: ON / OFF

Overflow / underflow diagnosis: ON / OFF

Representation values: Simatic S7 / Simatic S5 (*for ±80 mV only*)

Temperature unit: Celsius x 10 / Fahrenheit x 10 / Kelvin x 10

Parameters for each channel

Wire break detection: ON / OFF

Interference frequency suppression: None / 10 Hz / 50 Hz / 60 Hz / 400 Hz

Measuring ranges: ±80 mV

Thermocouples: E / J / K / N / R / S / T / B / C / L

Temperature compensation: internal / external / process data-based

Limit value alarms enabled: ON / OFF

Upper / lower limit: 16-bit analog value (±27648)

Technical specifications

Order no.	600-254-4AH22
Name	AI 8 x TC, Iso., 16-bit
Module ID / module type	7800 _{dec.} / 0x0288
Number of inputs	8
Electrically isolated from backplane bus	Yes
Channels electrically isolated from each other	Yes
Current draw	
External	Not needed
Internal	Max. 140 mA
Power dissipation	Max. 1 W
Measuring ranges	±80mV
Thermocouples	E (-270 °C ... 990 °C) J (-210 °C ... 1200 °C) K (-270 °C ... 1380 °C) N (-270 °C ... 1320 °C) R (-50 °C ... 1775 °C) S (-50 °C ... 1775 °C) T (-270 °C ... 405 °C) B (0 °C ... 1800 °C) C (0 °C ... 2320 °C) L (0 °C ... 900 °C)
Measurement resolution	15 bits + sign
Measuring method	Integration
Interference frequency suppression	None / 10 Hz / 50 Hz / 60 Hz / 400 Hz
Refresh rate / conversion rate	<i>Depends on the interference frequency suppression setting being used:</i> None: 3 ms 400 Hz: 8 ms 60 Hz: 51 ms 50 Hz: 60 ms 10 Hz: 160 ms
Diagnoses	Upper measuring limit exceeded (overflow) Lower measuring limit fallen below (underflow) Wire break Parameter assignment error
Process alarms	Upper and lower limit per channel
Error limits	
Operational error limit	±0.5% within the entire temperature range, relative to the nominal range
Basic error limit	±0.3%, operational error limit at 25 °C, relative to the nominal range
Temperature error	±0.005%/K, relative to the nominal range
Linearity error	±0.05%/K, relative to the nominal range
Repeating accuracy in steady state at 25 °C	±0.05%/K, relative to the nominal range
Parameter configuration length	51 bytes
General error indicator	Red LED
Weight	Approx. 110 g
Certification	UL 508

6.2. Analog Output Modules

6.2.1. 600-260-4AB01, AO 2 x I, 0/4–20 mA, 12-bit

Characteristics

- 2 analog outputs (electrically isolated from the backplane bus)
- 2 process output words (4 bytes)
- Output range 0 ... 20 mA, 4 ... 20 mA
- Resolution of up to 12 bits + sign
- Substitute value functionality
- Diagnostic messages
- A bi-color LED (blue/red) indicates the module's operating status and any malfunctions

Pin assignment

Connection	I/O
1	AO0 +
2	AO0 -
3	AO1 +
4	AO1 -
5	Mana
6	L+, 24 VDC
7	L+, 24 VDC
8	L-, GND
9	L-, GND
10	AUX

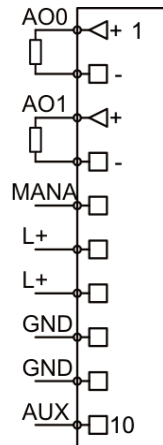

Parameters for the module

Diagnostic alarm: ON / OFF

Format of values: Simatic S7 / Simatic S5 / INT16

Parameters for each channel

Wire break detection: ON / OFF

Output ranges: 0 ... 20 mA / 4 ... 20 mA

Available substitute value options: Outputs de-energized / Retain last value / Apply substitute value

Substitute value: 16-bit analog value (± 27648)

Technical specifications

Order no.	600-260-4AB01
Name	AO 2 x I, 0/4–20 mA, 12-bit
Module ID / module type	8200 _{dec.} / 0x0220
Number of outputs	2
Output ranges	0 ... 20 mA 4 ... 20 mA
Electrically isolated from backplane bus	Yes
Channels electrically isolated from each other	No
Current draw	
External	Max. 60 mA
Internal	Max. 26 mA
Power dissipation	Max. 1.9 W
Connection for actuators	2-wire connection
Load resistance	Max. 600 ohms
Inductive load	Max. 100 mH
No-load voltage	Max. 18 V
Resolution	12 bits
Refresh time	0.2 ms
Settling time	0.2 ms for resistive loads 2.2 ms for capacitive loads 0.5 ms for inductive loads (≤ 1 mH) 3.3 ms for inductive loads (≤ 3.3 mH)
Diagnoses	No external reference voltage (L+) Wire break Parameter assignment error
Error limits	
Operational error limit	$\pm 0.5\%$ within the entire temperature range, relative to the nominal range
Basic error limit	$\pm 0.3\%$, operational error limit at 25 °C, relative to the nominal range
Temperature error	$\pm 0.005\%/K$, relative to the nominal range
Linearity error	$\pm 0.05\%/K$, relative to the nominal range
Repeating accuracy in steady state at 25 °C	$\pm 0.05\%/K$, relative to the nominal range
Parameter configuration length	7 bytes
General error indicator	Red LED
Weight	Approx. 70 g
Certification	UL 508

6.2.2. 600-260-4AD01, AO 4 x I, 0/4-20 mA, 12-bit

Characteristics

- 4 analog outputs (electrically isolated from the backplane bus)
- 4 process output words (8 bytes)
- Output range 0 ... 20 mA, 4 ... 20 mA
- Resolution of up to 12 bits
- Substitute value functionality
- Diagnostic messages
- A bi-color LED (blue/red) indicates the module's operating status and any malfunctions

Pin assignment

Connection	I/O
1	AO0 +
2	AO0 -
3	AO1 +
4	AO1 -
5	AO2 +
6	AO2 -
7	AO3 +
8	AO3 -
9	GND
10	AUX

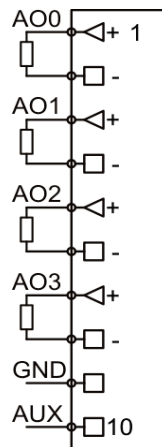

Parameters for the module

Diagnostic alarm: ON / OFF

Format of values: Simatic S7 / Simatic S5 / INT16

Parameters for each channel

Wire break detection: ON / OFF

Output range 0 ... 20 mA, 4 ... 20 mA

Available substitute value options: Outputs de-energized / Retain last value / Apply substitute value

Substitute value: 16-bit analog value (± 27648)

Technical specifications

Order no.	600-260-4AD01
Name	AO 4 x I, 0/4–20 mA, 12-bit
Module ID / module type	8400 _{dec.} / 0x0240
Number of outputs	4
Output ranges	0 ... 20 mA 4 ... 20 mA
Electrically isolated from backplane bus	Yes
Channels electrically isolated from each other	No
Current draw	
External	Max. 100 mA
Internal	Max. 26 mA
Power dissipation	Max. 3 W
Connection for actuators	2-wire connection
Load resistance	Max. 600 ohms
Inductive load	Max. 100 mH
No-load voltage	Max. 18 V
Resolution	12 bits
Refresh time	0.2 ms
Settling time	0.2 ms for resistive loads 2.2 ms for capacitive loads 0.5 ms for inductive loads (≤ 1 mH) 3.3 ms for inductive loads (≤ 3.3 mH)
Diagnoses	No external reference voltage (L+) Wire break Parameter assignment error
Error limits	
Operational error limit	$\pm 0.5\%$ within the entire temperature range, relative to the nominal range
Basic error limit	$\pm 0.3\%$, operational error limit at 25 °C, relative to the nominal range
Temperature error	$\pm 0.005\%/K$, relative to the nominal range
Linearity error	$\pm 0.05\%/K$, relative to the nominal range
Repeating accuracy in steady state at 25 °C	$\pm 0.05\%/K$, relative to the nominal range
Parameter configuration length	13 bytes
General error indicator	Red LED
Weight	Approx. 70 g
Certification	UL 508

6.2.3. 600-261-4AB01, AO 2 x U, ±10 V, 0–10 V, 1–5 V, 12-bit

Characteristics

- 2 analog outputs (electrically isolated from the backplane bus)
- 2 process output words (4 bytes)
- Output ranges: ±10 V, 0–10 V, 1–5 V
- Resolution of up to 12 bits + sign
- Substitute value functionality
- Diagnostic messages
- A bi-color LED (blue/red) indicates the module's operating status and any malfunctions

Pin assignment

Connection	I/O
1	AO0 +
2	AO0 -
3	AO1 +
4	AO1 -
5	Mana
6	L+, 24 VDC
7	L+, 24 VDC
8	L-, GND
9	L-, GND
10	AUX

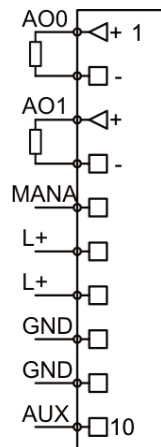

Parameters for the module

Diagnostic alarm: ON / OFF

Format of values: Simatic S7 / Simatic S5 / INT16

Parameters for each channel

Wire break detection: ON / OFF

Output ranges: ±10 V, 0–10 V, 1–5 V

Available substitute value options: Outputs de-energized / Retain last value / Apply substitute value

Substitute value: 16-bit analog value (±27648)

Technical specifications

Order no.	600-261-4AB01
Name	AO 2 x U, ± 10 V, 0–10 V, 1–5 V, 12-bit
Module ID / module type	9200 _{dec.} / 0x0220
Number of outputs	2
Output ranges	± 10 V 0–10 V 1–5 V
Electrically isolated from backplane bus	Yes
Channels electrically isolated from each other	No
Current draw	
External	Max. 45 mA
Internal	Max. 24 mA
Power dissipation	Max. 1.6 W
Connection for actuators	2-wire connection
Load resistance	Min. 1 kohm
Capacitive load	Max. 1 μ F
Short-circuit protection	Yes
Short-circuit current	Max. 25 mA
Resolution	12 bits + sign
Refresh time	0.2 ms
Settling time	0.2 ms for resistive loads 2.2 ms for capacitive loads 0.5 ms for inductive loads (≤ 1 mH) 3.3 ms for inductive loads (≤ 3.3 mH)
Diagnoses	No external reference voltage (L+) Configuration error
Error limits	
Operational error limit	$\pm 0.5\%$ within the entire temperature range, relative to the nominal range
Basic error limit	$\pm 0.3\%$, operational error limit at 25 °C, relative to the nominal range
Temperature error	$\pm 0.005\%/K$, relative to the nominal range
Linearity error	$\pm 0.05\%/K$, relative to the nominal range
Repeating accuracy in steady state at 25 °C	$\pm 0.05\%/K$, relative to the nominal range
Parameter configuration length	7 bytes
General error indicator	Red LED
Weight	Approx. 70 g
Certification	UL 508

6.2.4. 600-261-4AD01, AO 4 x U, ±10 V, 0–10 V, 1–5 V, 12-bit

Characteristics

- 4 analog outputs (electrically isolated from the backplane bus)
- 4 process output words (8 bytes)
- Output ranges: ±10 V, 0–10 V, 1–5 V
- Resolution of up to 12 bits + sign
- Substitute value functionality
- Diagnostic messages
- A bi-color LED (blue/red) indicates the module's operating status and any malfunctions

Pin assignment

Connection	I/O
1	AO0 +
2	AO0 -
3	AO1 +
4	AO1 -
5	AO2 +
6	AO2 -
7	AO3 +
8	AO3 -
9	GND
10	AUX

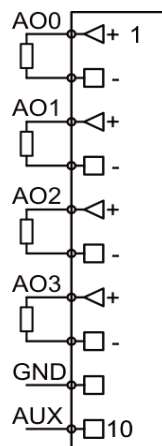

Parameters for the module

Diagnostic alarm: ON / OFF

Format of values: Simatic S7 / Simatic S5 / INT16

Parameters for each channel

Wire break detection: ON / OFF

Output ranges: ±10 V, 0–10 V, 1–5 V

Available substitute value options: Outputs de-energized / Retain last value / Apply substitute value

Substitute value: 16-bit analog value (±27648)

Technical specifications

Order no.	600-261-4AD01
Name	AO 4 x U, ± 10 V, 0–10 V, 1–5 V, 12-bit
Module ID / module type	9400 _{dec.} / 0x0240
Number of outputs	4
Output ranges	± 10 V 0–10 V 1–5 V
Electrically isolated from backplane bus	Yes
Channels electrically isolated from each other	No
Current draw	
External	Max. 75 mA
Internal	Max. 24 mA
Power dissipation	Max. 2.4 W
Connection for actuators	2-wire connection
Load resistance	Min. 1 kohm
Capacitive load	Max. 1 μ F
Short-circuit protection	Yes
Short-circuit current	Max. 25 mA
Resolution	12 bits + sign
Refresh time	0.2 ms
Settling time	0.2 ms for resistive loads 2.2 ms for capacitive loads 0.5 ms for inductive loads (≤ 1 mH) 3.3 ms for inductive loads (≤ 3.3 mH)
Diagnoses	No external reference voltage (L+) Configuration error
Error limits	
Operational error limit	$\pm 0.5\%$ within the entire temperature range, relative to the nominal range
Basic error limit	$\pm 0.3\%$, operational error limit at 25 °C, relative to the nominal range
Temperature error	$\pm 0.005\%/K$, relative to the nominal range
Linearity error	$\pm 0.05\%/K$, relative to the nominal range
Repeating accuracy in steady state at 25 °C	$\pm 0.05\%/K$, relative to the nominal range
Parameter configuration length	13 bytes
General error indicator	Red LED
Weight	Approx. 70 g
Certification	UL 508

6.3. Basic Analog Value Representation Principles

6.3.1. General Information

CPUs are only able to process analog values as binary values. Analog input modules convert analog input values into binary numbers with a resolution of 16 bits.

6.3.2. Analog Value Representation with 16-bit Resolution

Analog values are represented as two's complement fixed-point numbers. Each analog value's sign is always represented by bit 15, i.e., if bit 15 = 1, the value is negative.

	Sign	High-Byte								Low-Byte							
Bit	15	14	13	12	11	10	9	8	7	6	5	4	3	2	1	0	
Value of bit	2^{15}	2^{14}	2^{13}	2^{12}	2^{11}	2^{10}	2^9	2^8	2^7	2^6	2^5	2^4	2^3	2^2	2^1	2^0	

6.3.3. Reading Resolution

In certain analog input modules, the analog values' resolution may be lower than 15 bits. When the resolution is lower than 15 bits, the "x" bits are set to "0" starting from the bit with the lowest value.

Resolution in bits (+ sign)	Units		Analog value	
	Decimal	Hexadecimal	High-Byte	Low-Byte
10	32	20h	Sign 0 0 0 0 0 0 0	0 0 1 x x x x x
11	16	10h	Sign 0 0 0 0 0 0 0	0 0 0 1 x x x x
12	8	8h	Sign 0 0 0 0 0 0 0	0 0 0 0 1 x x x
13	4	4h	Sign 0 0 0 0 0 0 0	0 0 0 0 0 1 x x
14	2	2h	Sign 0 0 0 0 0 0 0	0 0 0 0 0 0 1 x
15	1	1h	Sign 0 0 0 0 0 0 0	0 0 0 0 0 0 0 1

6.4. Analog Value Representation in SIMATIC S7 Format

6.4.1. Simatic S7 Analog Value Representation for Voltage Measuring Ranges

System		Voltage measuring range				Range
Dec.	Hex.	±10 V	±5 V	±2.5 V	±80 mV	
32767	7FFF					Overflow
30720	7800					
30719	77FF	11.111 V	5.555 V	2.778 V	88.88 mV	Over-range
27649	6C01					
27648	6C00	10.000 V	5.000 V	2.500 V	80 mV	Nominal range
20736	5100	7.500 V	3.75 V	1.875 V		
1	1	361 µV	180 µV	90 µV	2.9 µV	
0	0	0 V	0 V	0 V	0 mV	
-1	FFFF	-361 µV	-180 µV	-90 µV	-2.9 µV	
-20736	AF00	-7.500 V	-3.750 V	-1.875 V		
-27648	9400	-10.000 V	-5.000 V	-2.500 V	-80 mV	
-27649	93FF					Under-range
-30719	8801	-11.111 V	-5.555 V	-2.778 V	-88.88 mV	
-30720	8800					Underflow
-32768	8000					

System		Voltage measuring range		Range	
Dec.	Hex.	1 to 5 V	0 to 10 V		
32767	7FFF			Overflow	
30720	7800				
30719	77FF	5.704 V	11.759 V	Over-range	
27649	6C01				
27648	6C00	5 V	10 V	Nominal range	
20736	5100	4 V	7.5 V		
1	1	1 V + 144 µV	361 µV		
0	0	1 V	0 V		
-1	FFFF	1 V + 144 µV	Negative values not allowed		Under-range
-4864	ED00	296 mV			
-4865	ECFF				Underflow
-32768	8000				

System		Voltage measuring range		Range
Dec.	Hex.	±24 V	±100 V	
32767	7FFF			Overflow
30720	7800			
30719	77FF	26.66 V	111.1 V	Over-range
27649	6C01			
27648	6C00	24.00 V	100.0 V	Nominal range
20736	5100	18.00 V	75.0 V	
1	1	0.86 mV	3.6 mV	
0	0	0 V	0 V	
-1	FFFF	0.86 mV	-3.6 mV	
-20736	AF00	-18.00 V	-75.0 V	
-27648	9400	-24.00 V	-100.0 V	
-27649	93FF			
-30719	8801	-26.66 V	-111.1 V	
-30720	8800			Underflow
-32768	8000			

6.4.2. Simatic S7 Analog Value Representation for Current Measuring Ranges

System		Current measuring range		Range
Dec.	Hex.	± 20 mA	0 ... 20 mA	
32767	7FFF			Overflow
30720	7800			
30719	77FF	22.22 mA	22.22 mA	Over-range
27649	6C01			
27648	6C00	20 mA	20 mA	Nominal range
20736	5100	15 mA	15 mA	
1	1	0.72 μ A	0.72 μ A	
0	0	0 mA	0 mA	
-1	FFFF	-0.72 μ A	Negative values not allowed	
-4864	ED00	-3.52 mA		
-20736	AF00	-15 mA		
-27648	9400	-20 mA		
-27649	93FF			
-30719	8801	-22.22 mA		
-30720	8800		Under-range	
-32768	8000		Underflow	

System		Current measuring range		Range
Dec.	Hex.	4–20 mA		
32767	7FFF			Overflow
30720	7800			
30719	77FF	22.22 mA		Over-range
27649	6C01			
27648	6C00	20 mA		Nominal range
20736	5100	16 mA		
1	1	4 mA + 0.58 μ A		
0	0	4 mA		
-1	FFFF	4 mA – 0.58 μ A		
-4864	ED00	1.185 mA		
-4865	AF00			Underflow
-32768	8000			

6.4.3. Simatic S7 Analog Value Representation for Resistance Measuring Range

System	Resistance measuring range						Range
	Dec.	Hex.	150 Ω	300 Ω	600 Ω	3000 Ω	
32767	7FFF						Overflow
30720	7800						
30719	77FF	166.66 Ω	333.32 Ω	666.64 Ω	3333 Ω	6666 Ω	Over-range
27649	6C01						
27648	6C00	150 Ω	300 Ω	600 Ω	3000 Ω	6000 Ω	Nominal range
20736	5100	112.5 Ω	225 Ω	450 Ω	2250 Ω	4500 Ω	
13824	3600	75 Ω	150 Ω	300 Ω	1500 Ω	3000 Ω	
1	1	5.43 mΩ	10.85 mΩ	21.70 mΩ	108.5 mΩ	217.0 mΩ	
0	0	0 Ω	0 Ω	0 Ω	0 Ω	0 Ω	
(Negative values are physically impossible)							Under-range

6.4.4. Analog value representation for PT100/PT1000 Standard

Temperature in °C	Units		Temperature in °F	Units		Temperature in K	Units	
	Dec.	Hex.		Dec.	Hex.		Dec.	Hex.
> 1000.0	32767	7FFF	>1832.0	32767	7FFF	>1273.2	32767	7FFF
1000.0	10000	2710	1832.0	18320	4790	1273.2	12732	31BC
850.1	8501	2135	1562.3	15623	3D07	1123.2	11232	2BE0
850.0	8500	2134	1562.2	15622	3D06	1123.1	11231	2BDF
1.0	10	000A	33.8	338	0152	274.2	2742	0AB6
0.1	1	0001	32.2	322	0142	273.3	2733	0AAD
0.0	0	0000	32.0	320	0140	273.2	2732	0AAC
-200.0	-2000	F830	-328.0	-3280	F330	73.2	732	02DC
-200.1	-2001	F82F	-328.1	-3281	F32F	73.1	731	02DB
-240.0	-2400	F6A0	-400.0	-4000	F060	33.2	332	014C
< -240,0	-32768	8000	< -400,0	-32768	8000	< 33,2	-32768	8000

Note: The ranges with a gray background are overdrive or underdrive ranges

6.4.5. Analog value representation for Ni100/Ni1000/LGNi1000 Standard

Temperature in °C	Units		Temperature in °F	Units		Temperature in K	Units	
	Dec.	Hex.		Dec.	Hex.		Dec.	Hex.
> 295.0	32767	7FFF	> 563.1	32767	7FFF	> 568.2	32767	7FFF
295.0	2950	0B86	563.0	5630	15FE	568.2	5682	1632
250.1	2501	09C5	482.1	4821	0F51	523.3	5233	1471
250.0	2500	09C4	482.0	4820	0F50	523.2	5232	1470
1.0	10	000A	33.8	338	0152	274.2	2742	0AB6
0.1	1	0001	32.2	322	0142	273.3	2733	0AAD
0.0	0	0000	32.0	320	0140	273.2	2732	0AAC
-60.0	-600	FDA8	-76.0	-760	FD08	213.2	2132	0854
-60.1	-601	FDA7	-76.1	-761	FD07	213.1	2131	0853
-110.0	-1100	FBB4	-166.0	-1660	F984	163.2	1632	0660
< -110,0	-32768	8000	< -166,0	-32768	8000	< 163,2	-32768	8000

Note: The ranges with a gray background are overdrive or underdrive ranges

6.4.6. Analog value representation for PT100/PT1000 climate

Temperature in °C	Units		Temperature in °F	Units	
	Dec.	Hex.		Dec.	Hex.
> 155.00	32767	7FFF	> 311.00	32767	7FFF
155.00	15500	3C8C	311.00	31100	797C
130.01	13001	32C9	266.02	26602	67EA
130.00	13000	32C8	266.00	26600	67E8
1.00	100	0064	33.80	3380	0D34
0.01	1	0001	32.02	3202	0C82
0.00	0	0000	32.00	3200	0C80
-120.00	-12000	D120	-184.00	-18400	B820
-120.01	-12001	D121	-184.02	-18402	B81E
-145.00	-14500	C75C	-229.00	-22900	A68C
< -145,00	-32768	8000	< -229,00	-32768	8000

Note 1: The ranges with a gray background are overdrive or underdrive ranges

Note 2: In the case of PT100/PT1000 climate, a representation in kelvin is not possible.

6.4.7. Analog Value Representation for TC

The way in which analog values for thermocouples are represented is the same as that used for RTD sensors (e.g., PT100). However, the actual temperature ranges depend on the thermocouple type being used:

Type B	0 ... +1800 °C
Type E	-270 – +990 °C
Type J	-210 ... +1200 °C
Type L	0 – +900 °C
Type K	-270 ... +1380 °C
Type N	-270 ... +1320 °C
Type R	-50 ... +1775 °C
Type S	-50 ... +1775 °C
Type T	-270 ... +405 °C
Type C	0 ... +2320 °C

6.5. Analog Value Representation in SIMATIC S5 Format

6.5.1. Simatic S5 Analog Value Representation for Voltage Measuring Ranges

System		Voltage measuring range				Range
Dec.	Hex.	±10 V	±5 V	±2.5 V	±80 mV	
32767	7FFF					Overflow
18432	4800					
18431	47FF	11.25 V	5.62 V	2.81 V	90 mV	Over-range
16385	4001					
16384	4000	10.000 V	5.000 V	2.500 V	80 mV	Nominal range
12288	3000	7.500 V	3.75 V	1.875 V		
1	1	610 µV	305 µV	152 µV	4.8 µV	
0	0	0 V	0 V	0 V	0 mV	
-1	FFFF	-610 µV	-305 µV	-152 µV	- 4.8 µV	
-12228	D000	-7.500 V	-3.750 V	-1.875 V		
-16384	C000	-10.000 V	-5.000 V	-2.500 V	-80 mV	
-16385	BFFF					Under-range
-18431	B801	-11.25 V	-5.62 V	-2.81 V	-90 mV	
-18432	B800					Underflow
-32768	8000					

System		Voltage measuring range		Range
Dec.	Hex.	1 to 5 V	0 to 10 V	
32767	7FFF			Overflow
30720	7800			
30719	77FF	5.5 V	11.25 V	Over-range
16385	4001			
16384	4000	5 V	10 V	Nominal range
12288	3000	4 V	7.5 V	
1	1	1 V + 244 µV	610 µV	
0	0	1 V	0 V	
-1	FFFF	1 V + 244 µV	Negative values not allowed	Under-range
-2048	F800	0.5 V		
-2049	F7FF			Underflow
-32768	8000			

6.5.2. Simatic S5 Analog Value Representation for Current Measuring Ranges

System		Current measuring range		Range
Dec.	Hex.	± 20 mA	0 ... 20 mA	
32767	7FFF			Overflow
18432	4800			
18431	47FF	22.5 mA	22.5 mA	Over-range
16385	4001			
16384	4000	20 mA	20 mA	Nominal range
12288	3000	15 mA	15 mA	
1	1	1.22 μ A	1.22 μ A	
0	0	0 mA	0 mA	
-1	FFFF	-1.22 μ A	Negative values not allowed	
-12228	D000	-15 mA		
-16384	C000	-20 mA		
-16385	BFFF			
-18431	B801	-22.5 mA		
-18432	B800			
-32768	8000			Underflow

System		Current measuring range		Range
Dec.	Hex.	4 ... 20 mA		
32767	7FFF			Overflow
30720	7800			
30719	77FF	22.5 mA		Over-range
16385	4001			
16384	4000	20 mA		Nominal range
12288	3000	16 mA		
1	1	4 mA + 0.98 μ A		
0	0	4 mA		
-1	FFFF	4 mA - 0.98 μ A		
-2048	F800	1.185mA		
-2049	F7FF			Underflow
-32768	8000			

6.5.3. Simatic S5 Analog Value Representation for Resistance Measuring Range

System	Resistance measuring range						Range
	Dec.	Hex.	150 Ω	300 Ω	600 Ω	3000 Ω	
32767	7FFF						Overflow
18432	4800						
18431	47FF	168.74 Ω	337.48 Ω	674.96 Ω	3374 Ω	6749 Ω	Over-range
16385	4001						
16384	4000	150 Ω	300 Ω	600 Ω	3000 Ω	6000 Ω	Nominal range
12288	3000	112.5 Ω	225 Ω	450 Ω	2250 Ω	4500 Ω	
8192	2000	75 Ω	150 Ω	300 Ω	1500 Ω	3000 Ω	
1	1	9.16 mΩ	18.3 mΩ	27.3 mΩ	183 mΩ	366 mΩ	
0	0	0 Ω	0 Ω	0 Ω	0 Ω	0 Ω	
(Negative values are physically impossible)							Under-range

6.6. Analog Value Representation in INT16 Format

6.6.1. INT16 Analog Value Representation for Voltage Measuring Ranges

The value format INT16 knows no overflow or underflow. If the maximum PLC value is reached, this value also stops when the nominal range is exceeded.

System		Voltage measuring range			Range
Dec.	Hex.	±10 V	±5 V	±2.5 V	
32767	7FFF	10.000 V	5.000 V	2.500 V	Nominal range
24575	5FFF	7.500 V	3.75 V	1.875 V	
1	1	305 µV	152 µV	76 µV	
0	0	0 V	0 V	0 V	
-1	FFFF	-305 µV	-152 µV	-76 µV	
-24575	A000	-7.500 V	-3.750 V	-1.875 V	
-32768	8000	-10.000 V	-5.000 V	-2.500 V	

System		Voltage measuring range		Range
Dec.	Hex.	1 to 5 V	0 to 10 V	
32767	7FFF	5 V	10 V	Nominal range
24575	5FFF	4 V	7.5 V	
1	1	1 V + 122 µV	305 µV	
0	0	1 V	0 V	

System		Voltage measuring range		Range
Dec.	Hex.	±24 V	±100 V	
32767	7FFF	24.00 V	100.0 V	Nominal range
24575	5FFF	18.00 V	75.0 V	
1	1	0.73 mV	3.05 mV	
0	0	0 V	0 V	
-1	FFFF	0.73 mV	-3.05 mV	
-24575	A000	-18.00 V	-75.0 V	
-32768	8000	-24.00 V	-100.0 V	

6.6.2. INT16 Analog Value Representation for Current Measuring Ranges

System		Current measuring range		Range
Dec.	Hex.	± 20 mA	0 ... 20 mA	
32767	7FFF	20 mA	20 mA	Nominal range
24575	5FFF	15 mA	15 mA	
1	1	0.61 μ A	0.61 μ A	
0	0	0 mA	0 mA	
-1	FFFF	-0.61 μ A	Negative values not allowed	
-24575	A000	-15 mA		
-32768	8000	-20 mA		

System		Current measuring range		Range
Dec.	Hex.	4–20 mA		
32767	7FFF	20 mA	Nominal range	
24575	5FFF	16 mA		
1	1	4 mA + 0.48 μ A		
0	0	4 mA		

6.7. Definition of Operational Error Limit and Basic Error Limit

6.7.1. Operational error limit

“Operational error limit” is the analog input module’s error in measurement, within the entire permissible temperature range, relative to the module’s nominal range.

6.7.2. Basic error limit

“Basic error limit” is the operational error limit at 25 °C, relative to the module’s nominal range.

6.7.3. Example Showing How to Calculate the Input Error for an Analog Input Module

For this example, assume that a 600-252-4AD01 analog input module is being used with a “0 to 10 V” input range. The module will be operated at an ambient temperature of 30 °C. This is why the input error must be calculated on the basis of the operational error limit.

The relevant technical specifications indicate the following:

Operational error limit: $\pm 0.5\%$

The input error for the module’s entire nominal range is:

$\pm 0.5\%$ at 10 V = ± 0.05 V

Input error	± 0.05 V	± 0.05 V	± 0.05 V	± 0.05 V	± 0.05 V
Input value	1 V	2.5 V	5 V	8 V	10 V
Reading	0.95 ... 1.05 V	2.45 ... 2.55 V	4.95 ... 5.05 V	7.95 ... 8.05 V	9.95 ... 10.05 V
Relative error	5%	2%	1%	0.625%	$\pm 0.5\%$

6.8. Connecting Sensors to Analog Inputs

6.8.1. Abbreviations Used

- M+ Measuring line (positive)
- M- Measuring line (negative)
- M_{Ana} Reference potential of the analog circuit
- L+ 24 VDC power supply terminal
- GND Ground terminal

6.8.2. Signal Cables

Shielded twisted pair cables should be used for the analog signals. The analog cables' shielding should be grounded at both ends of the cable.

Signal cables should not run parallel to power cables. In addition, signal and data cables must be routed in conduits or bundles separate from those for power cables. Make sure to route signal and data cables as close as possible to grounding surfaces, e.g., on stringers, metal rails, mounting plates, or the metal sheets making up a cabinet or enclosure.

Motor cables, power supply cables connected to the power grid, and IT cables must be routed with a distance of at least 0.2 m between each other within the equipment cabinet. If there are any crossings, there can be a smaller distance between them. Outside the equipment cabinet, motor cables must be routed in separate bundles at a distance of at least 0.3 m from other cables. This will reduce the amount of interference caused by induction.

If a joint is necessary, no more than 2 cm should be unshielded. The shielding on both cable ends must be connected with the shielding bus, not with a terminal. The cable's shielding should not be connected to analog ground M_{Ana}.

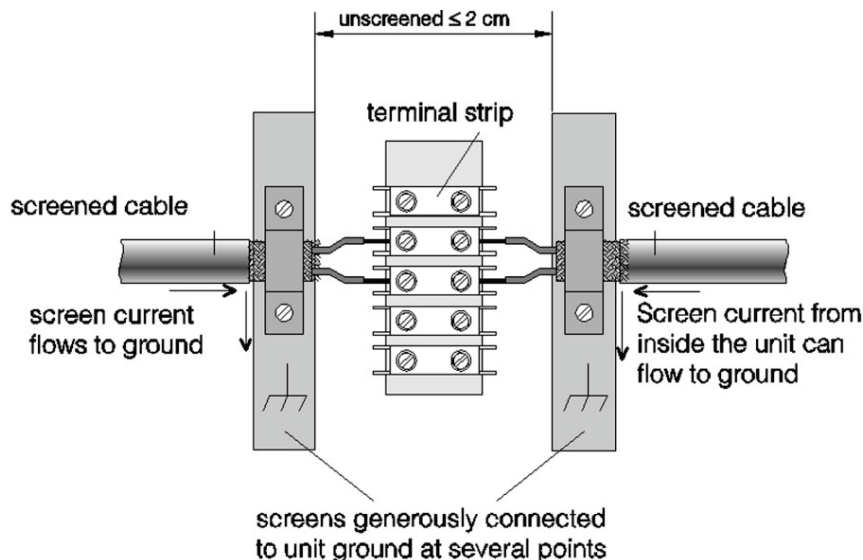

6.8.3. Connecting Voltage Transmitters

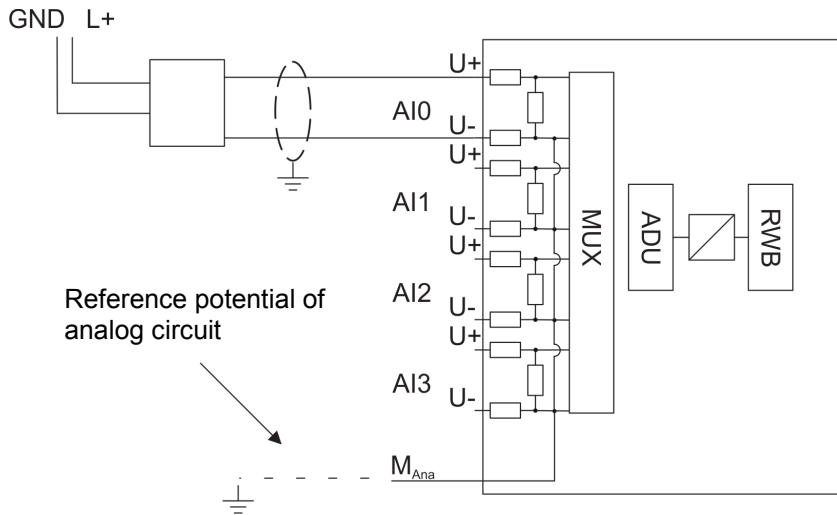

6.8.4. Connecting Current Transmitters

2-wire transducer:

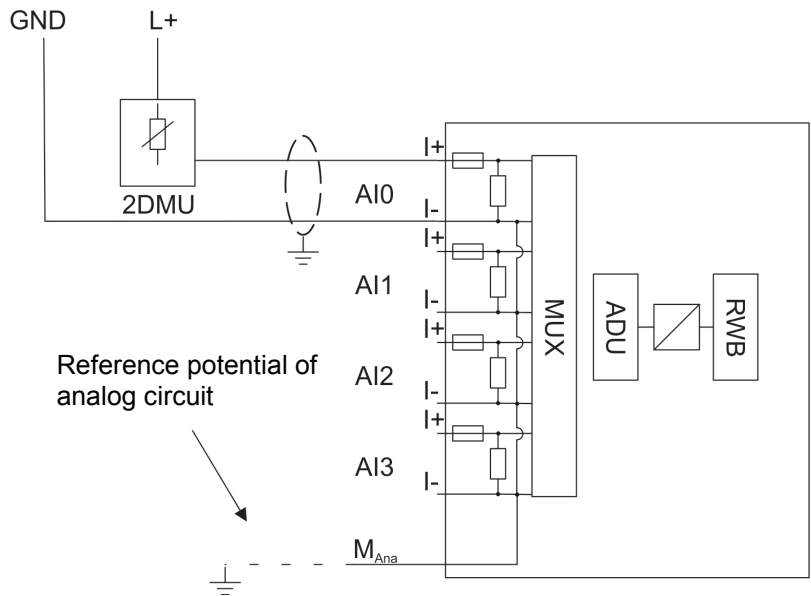

4-wire transducer:

4-wire transmitters have a separate supply voltage.

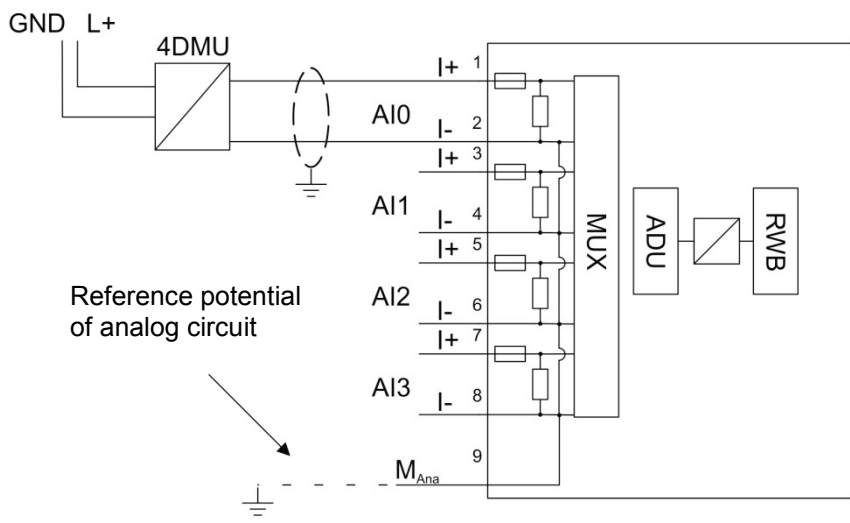

6.8.5. Connecting Resistance Thermometers and Resistors

Resistance thermometers and resistors are wired with a 4-wire, 3-wire, or 2-wire configuration.

When a 4-wire or 3-wire configuration is used, the module will deliver a constant current so that the voltage drop that occurs on the measuring lines will be compensated for. It is important for the connected constant current cables to be connected directly to the resistance thermometer/resistor! Measurements with 4-wire or 3-wire configuration provide more accurate results than measurements with 2-wire configuration.

2-wire measurement:

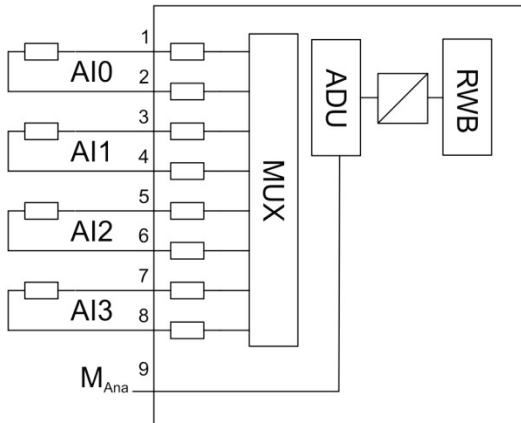

3-wire measurement:

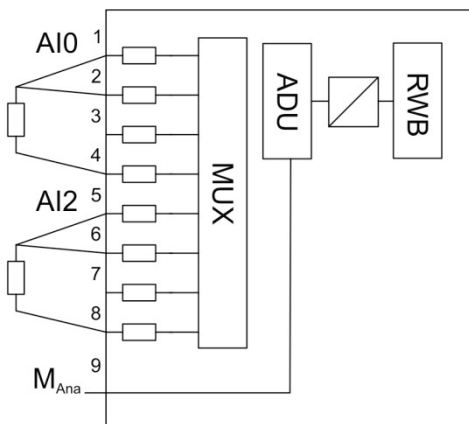

4-wire measurement:

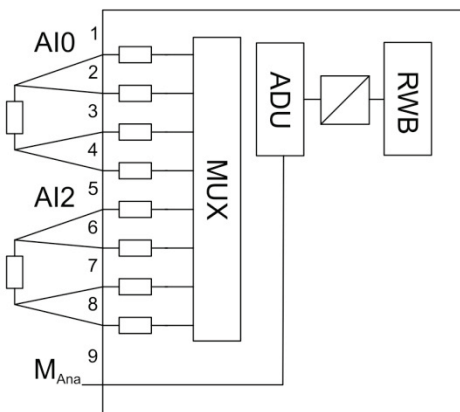

6.8.6. Connecting Thermocouples

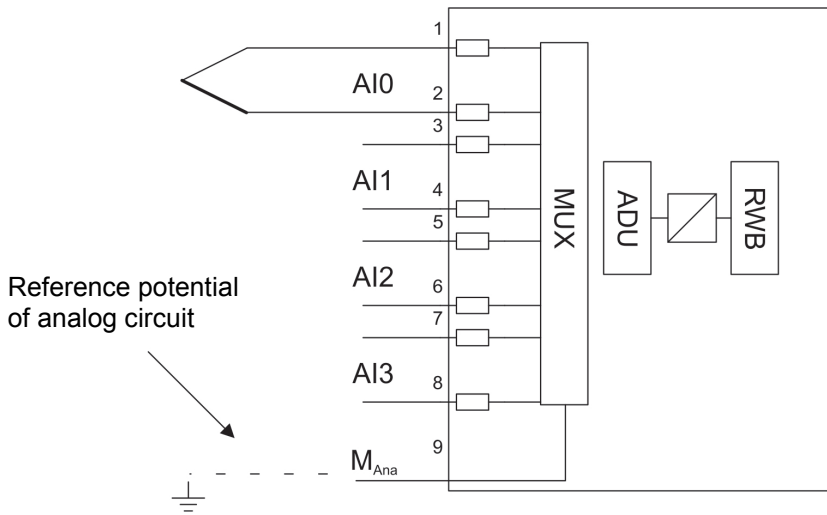

6.9. Connecting Loads and Actuators to Analog Outputs

6.9.1. Abbreviations Used

U Analog voltage output

I+ Analog current output

M_{Ana} Reference potential of the analog circuit

L+ 24 VDC power supply terminal

GND Ground terminal

6.9.2. Connecting Loads/Actuators to Voltage Outputs

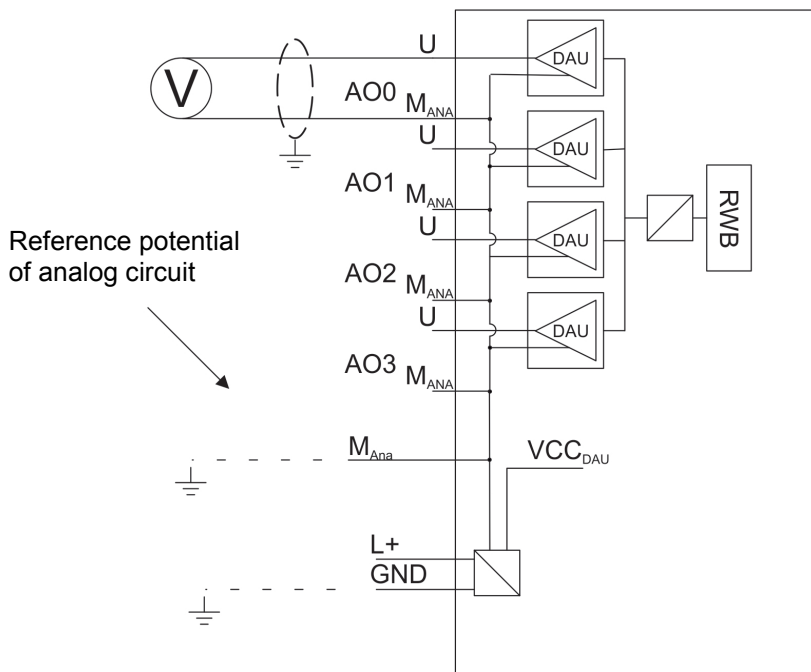

6.9.3. Connecting Loads/Actuators to Current Outputs

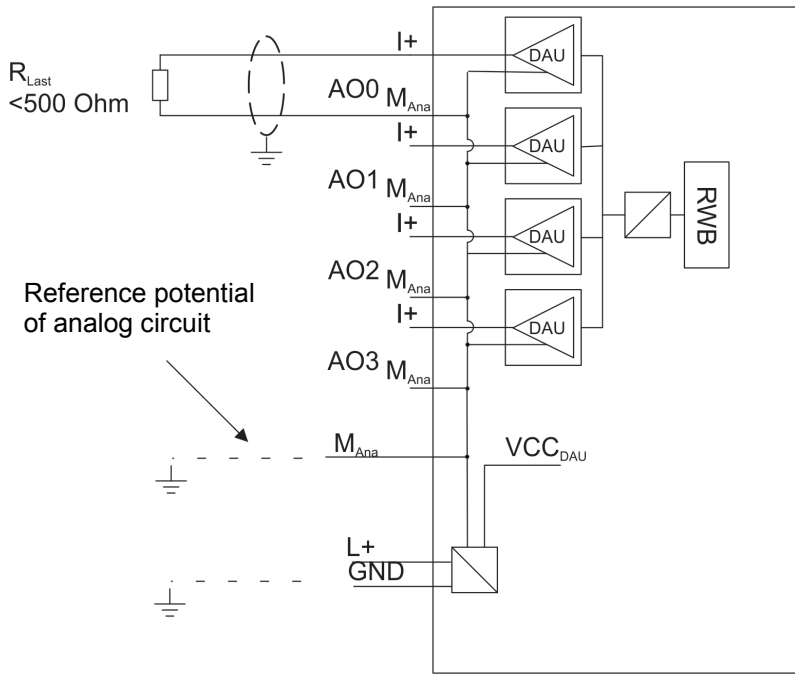

7. System Components

7.1. Power and isolation modules

7.1.1. 600-710-0AA01, 24 VDC, 8 A Power and Isolation Module

The 24 VDC, 8 A power and isolation module serves as a power supply module for the power bus' 24 VDC, GND, and AUX to the right, while segmenting the power bus on the left. This module can be used to subdivide a power bus into individual segments.

Characteristics

- Powers the power bus to the right
- Segments the power bus on the left
- A green LED indicates the 24 VDC status
- A blue LED indicates the module's operating status

Pin assignment

Connection	I/O
1	L+, 24 VDC
2	L+, 24 VDC
3	L+, 24 VDC
4	L+, 24 VDC
5	GND
6	GND
7	GND
8	GND
9	AUX
10	AUX

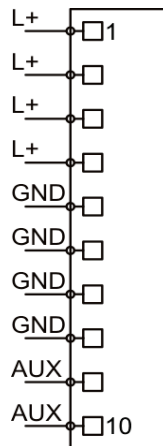

Technical data

Order no.	600-710-0AA01
Name	24 VDC, 8 A power and isolation module
Module ID / module type	30050 _{dec.} / 0x1000
Load	
Per contact	8 A
Total 24 VDC supply	8 A
Total GND supply	8 A
Total AUX supply	8 A
Current draw	
External	Max. 22 mA
Internal	Max. 5 mA
Power dissipation	Max. 0.3 W
Electrically isolated from backplane bus	Yes
Weight	Approx. 70 g
Certification	UL 508

The power and isolation module's power supply must be externally fused with a fast-blow fuse appropriate for the required maximum current.

7.2. Potential Distributors

7.2.1. 600-730-4AD01, potential distributor 4 x DC 24 V, High Feature

The 4 x 24 VDC High Feature potential distributor can be used to power up to four transducers or 3-wire sensors. Moreover, it features a monitoring functionality that not only monitors the 24 V load voltage but also monitors for overload and short-circuit conditions at the supply outputs. In the event of a fault, the module will send a diagnostic signal to the PLC and change the color of the corresponding LEDs to red.

Characteristics

- 4 outputs, electrically isolated from the backplane bus
- 24 VDC output voltage
- 100 mA output voltage per channel
- A blue LED indicates the module's operating status
- Short-circuit protection with self-resetting fuse per channel
- Green/red LEDs indicate the outputs' states
- 24 V load voltage monitoring and diagnosis
- Short circuit to GND monitoring and diagnosis for each individual channel
- 1 Byte channel status information in input image table

Pin assignment

Connection	I/O
1	MS0, DC 24 V
2	GND
3	MS1, DC 24 V
4	GND
5	MS2, DC 24 V
6	GND
7	MS3, DC 24 V
8	GND
9	L+, 24 VDC
10	AUX

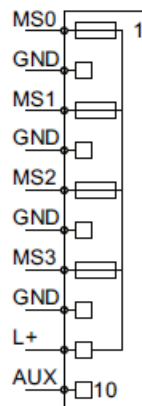

Input area (1 Byte)

	Bit 7	Bit 6	Bit 5	Bit 4	Bit 3	Bit 2	Bit 1	Bit 0
Byte 0	1= 24 V Power supply off	0	0	0	Channel 3: 0=OK 1 = error	Channel 2: 0=OK 1 = error	Channel 1: 0=OK 1 = error	Channel 0: 0=OK 1 = error

Technical data

Order no.	600-730-4AD01
Name	4 x 24 VDC High Feature potential distributor
Module ID / module type	31100 _{dec.} / 0x3004
Number of outputs	4
Electrically isolated from backplane bus	Yes
Current draw	

External	10 mA + load
Internal	Max. 30 mA
Power dissipation	Max. 0.1 W
Load per output	100 mA
Output short-circuit protection	Fuse per channel, self-resetting
Weight	Approx. 70 g
Certification	UL 508

7.2.2. 600-720-0AH01, potential distributor 9 x DC 24 V

The 9 x 24 VDC potential distributor makes the 24 VDC supply from the power bus available on the front connector.

Characteristics

- Max. 8 A supply load
- Powers its outputs using the power bus
- A blue LED indicates the module's operating status

Pin assignment

Connection	I/O
1	L+, 24 VDC
2	L+, 24 VDC
3	L+, 24 VDC
4	L+, 24 VDC
5	L+, 24 VDC
6	L+, 24 VDC
7	L+, 24 VDC
8	L+, 24 VDC
9	L+, 24 VDC
10	AUX

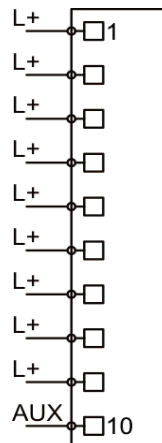

Technical data

Order no.	600-720-0AH01
Name	9 x 24 VDC potential distributor
Module ID / module type	31000 _{dec.} / 0x3000
Number of outputs	9
Electrically isolated from backplane bus	Yes
Current draw	
External	0 mA
Internal	Max. 22 mA
Power dissipation	Max. 0.1 W
Load	
Per contact	8 A
Total load	8 A
Weight	Approx. 70 g
Certification	UL 508

7.2.3. 600-720-0BH01, 9 x GND Potential Distributor

The 9 x GND potential distributor makes the GND connection from the power bus available on the front connector.

Characteristics

- Max. 8 A supply load
- Powers its outputs using the power bus
- A blue LED indicates the module's operating status

Pin assignment

Connection	I/O
1	GND
2	GND
3	GND
4	GND
5	GND
6	GND
7	GND
8	GND
9	GND
10	AUX

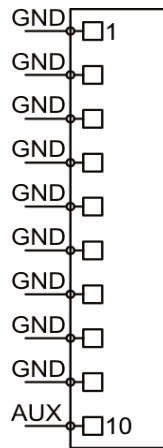

Technical data

Order no.	600-720-0BH01
Name	9 x GND potential distributor
Module ID / module type	31010 _{dec.} / 0x3000
Number of outputs	9
Electrically isolated from backplane bus	Yes
Current draw	
External	0 mA
Internal	Max. 22 mA
Power dissipation	Max. 0.1 W
Load	
Per contact	8 A
Total load	8 A
Weight	Approx. 70 g
Certification	UL 508

7.2.4. 600-720-0CH01, 10 x AUX Potential Distributor

The 10 x AUX potential distributor makes the AUX connection from the power bus available on the front connector.

Characteristics

- Max. 8 A supply load
- Powers its outputs using the power bus
- A blue LED indicates the module's operating status

Pin assignment

Connection	I/O
1	AUX
2	AUX
3	AUX
4	AUX
5	AUX
6	AUX
7	AUX
8	AUX
9	AUX
10	AUX

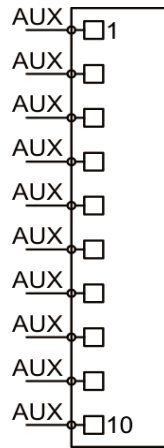

Technical data

Order no.	600-720-0CH01
Name	10 x AUX potential distributor
Module ID / module type	31020 _{dec.} / 0x3000
Number of outputs	10
Electrically isolated from backplane bus	Yes
Current draw	
External	0 mA
Internal	Max. 22 mA
Power dissipation	Max. 0.1 W
Load	
Per contact	8 A
Total load	8 A
Weight	Approx. 70 g
Certification	UL 508

7.2.5. 600-720-0DH01, potential distributor 4 x DC 24 V + 4 x GND

The 4 x 24 VDC + 4 x GND potential distributor makes the 24 V supply and the GND connection from the power bus available on the front connector.

Characteristics

- Max. 8 A supply load
- Powers its outputs using the power bus
- A blue LED indicates the module's operating status

Pin assignment

Connection	I/O
1	L+, 24 VDC
2	L+, 24 VDC
3	L+, 24 VDC
4	L+, 24 VDC
5	GND
6	GND
7	GND
8	GND
9	AUX
10	AUX

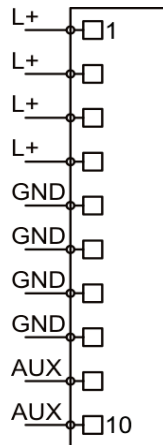

Technical data

Order no.	600-720-0DH01
Name	4 x 24 VDC + 4 x GND potential distributor
Module ID / module type	31030 _{dec.} / 0x3000
Number of outputs	10 in three groups: 4 x 24 VDC, 4 x GND, 2 x AUX
Electrically isolated from backplane bus	Yes
Current draw	
External	0 mA
Internal	Max. 22 mA
Power dissipation	Max. 0.1 W
Load	
Per contact	8 A
Total load, 24 VDC	8 A
Total load, GND	8 A
Total load, AUX	8 A
Weight	Approx. 70 g
Certification	UL 508

7.2.6. 600-720-0XH01, 9 x Free Pot. distributor

The “9 x Free Pot.” distributor makes 9 contacts that are connected to each other available on the front connector. The potential distributed through these contacts can be freely chosen.

Characteristics

- Max. 8 A supply load
- Can accommodate any supply potential
- A blue LED indicates the module's operating status

Pin assignment

Connection	I/O
1	External pot.
2	External pot.
3	External pot.
4	External pot.
5	External pot.
6	External pot.
7	External pot.
8	External pot.
9	External pot.
10	AUX

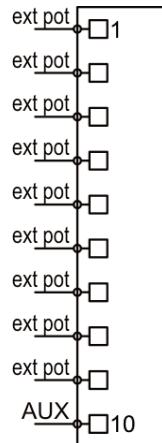

Technical data

Order no.	600-720-0XH01
Name	9 x free pot. potential distributor
Module ID / module type	31040 _{dec.} / 0x3000
Number of outputs	9
Electrically isolated from backplane bus	Yes
Current draw	
External	0 mA
Internal	Max. 22 mA
Power dissipation	Max. 0.1 W
Load	
Per contact	8 A
Total load	8 A
Permissible potential difference relative to GND	48 VAC
Weight	Approx. 70 g
Certification	UL 508

7.3. Power supply

7.3.1. 600-700-0AA01, 24 VDC Power Module

The 24 VDC power module provides a new supply voltage for the backplane bus and also serves as a power and isolation module for the power bus' 24 VDC, GND, and AUX.

Characteristics

- New supply voltage for the backplane bus
- 2.5 A, 5 VDC output current for the backplane bus
- Powers the power bus to the right
- Segments the power bus on the left
- A green LED indicates the 24 VDC status
- Diagnostic messages in the event of a loss of voltage or short circuit on the backplane bus
- A bi-color LED (blue/red) indicates the module's operating status and any malfunctions

Pin assignment

Connection	I/O
1	24 VDC IN
2	GND IN
3	-
4	L+, 24 VDC
5	L+, 24 VDC
6	GND
7	GND
8	-
9	L+, 24 VDC
10	AUX

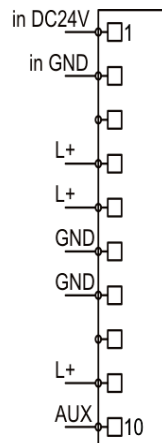

Parameters for the module

Diagnostic alarms: not enabled / enabled

Technical specifications

Order no.	600-700-0AA01
Name	24 VDC power module
Module ID / module type	30000 _{dec.} / 0x2000
Electrically isolated from backplane bus	No
Current draw	
External	Max. 10 mA + load
Internal	Max. 35 mA
24 VDC supply	18–30 VDC
Rated input current	Max. 8 A, overcurrent protection device
Reverse polarity protection	Up to 60 V, electronic
Power dissipation	Max. 0.7 W

Load	
Per contact	8 A
Total load, 24 VDC	8 A
Total load, GND	8 A
Total load, AUX	8 A
General error indicator	Red LED
Weight	Approx. 70 g
Certification	UL 508

The power module's power supply must be externally fused with a fast-blow fuse appropriate for the required maximum current.

8. Configuring the Modules' Parameters

8.1. General Information

All configurable modules come with a default parameter configuration. Depending on the bus system being used, the bus coupler will automatically load the desired operating parameter configuration into the modules when starting up or the user will have to transfer the configuration from the PLC by using the relevant methods.

When using bus couplers with project storage capabilities (e.g., CANopen couplers), the parameters can be configured in advance with the "TB20 ToolBox" software.

Modules can also be reconfigured at any time—even during operation. The methods that have to be used for this purpose will vary depending on the bus system and PLC being used.

The following section goes over the structure of the relevant parameter data sets. The corresponding default settings are underlined.

Note: All word and double word parameters are in big-endian format. Depending on the coupler used, these parameters are already correctly interpreted or need to be sent by the user in the correct order.

8.2. Digital Output Modules

8.2.1. 600-220-7AD01, DO 4 x DC 24 V, 700 mA, High Feature

Parameter set length: 6 bytes

Parameter	Byte	Bit 7	Bit 6	Bit 5	Bit 4	Bit 3	Bit 2	Bit 1	Bit 0
1	0	Diagnosis alarm	-	-	-	-	-		
2	1	Channel 3 behavior at CPU-STOP		Channel 2 behavior at CPU-STOP		Channel 1 behavior at CPU-STOP		Channel 0 behavior at CPU-STOP	
3	2	Pulse extension for channel 0							
4	3	Pulse extension for channel 1							
5	4	Pulse extension for channel 2							
6	5	Pulse extension for channel 3							

Diagnostic alarm: 1 = ON / 0 = OFF

Behavior at CPU-STOP 0 = Output Off / 1= Output On / 2 = Keep last value

Pulse extension: 0 = none / 1–255 = time (* 5ms)

8.2.2. 600-220-7AH01, DO 8 x DC 24 V, 700 mA, High Feature

Parameter set length: 11 bytes

Parameter	Byte	Bit 7	Bit 6	Bit 5	Bit 4	Bit 3	Bit 2	Bit 1	Bit 0
1	0	Diagnosis alarm	-	-	-	-	-		
2	1	Channel 3 behavior at CPU-STOP		Channel 2 behavior at CPU-STOP		Channel 1 behavior at CPU-STOP		Channel 0 behavior at CPU-STOP	
3	2	Channel 7 behavior at CPU-STOP		Channel 6 behavior at CPU-STOP		Channel 5 behavior at CPU-STOP		Channel 4 behavior at CPU-STOP	
4	3	Pulse extension for channel 0							
5	4	Pulse extension for channel 1							
6	5	Pulse extension for channel 2							
7	6	Pulse extension for channel 3							
8	7	Pulse extension for channel 4							
9	8	Pulse extension for channel 5							
10	9	Pulse extension for channel 6							
11	10	Pulse extension for channel 7							

Diagnostic alarm: 1 = ON / 0 = OFF

Behavior at CPU-STOP 0 = Output Off / 1= Output On / 2 = Keep last value

Pulse extension: 0 = none / 1–255 = time (* 5ms)

8.2.3. 600-220-7AP21, DO 16 x DC 24 V, 700 mA, High Feature

Parameter set length: 21 bytes

Parameter	Byte	Bit 7	Bit 6	Bit 5	Bit 4	Bit 3	Bit 2	Bit 1	Bit 0
1	0	Diagnosis alarm	-	-	-	-	-		
2	1	Channel 3 behavior at CPU-STOP		Channel 2 behavior at CPU-STOP		Channel 1 behavior at CPU-STOP		Channel 0 behavior at CPU-STOP	
3	2	Channel 7 behavior at CPU-STOP		Channel 6 behavior at CPU-STOP		Channel 5 behavior at CPU-STOP		Channel 4 behavior at CPU-STOP	
4	3	Channel 11 behavior at CPU-STOP		Channel 10 behavior at CPU-STOP		Channel 9 behavior at CPU-STOP		Channel 8 behavior at CPU-STOP	
5	4	Channel 15 behavior at CPU-STOP		Channel 14 behavior at CPU-STOP		Channel 13 behavior at CPU-STOP		Channel 12 behavior at CPU-STOP	
6	5	Pulse extension for channel 0							
7	6	Pulse extension for channel 1							
8	7	Pulse extension for channel 2							
9	8	Pulse extension for channel 3							
10	9	Pulse extension for channel 4							
11	10	Pulse extension for channel 5							
12	11	Pulse extension for channel 6							
13	12	Pulse extension for channel 7							
14	13	Pulse extension for channel 8							
15	14	Pulse extension for channel 9							
16	15	Pulse extension for channel 10							
17	16	Pulse extension for channel 11							
18	17	Pulse extension for channel 12							
19	18	Pulse extension for channel 13							
20	19	Pulse extension for channel 14							
21	20	Pulse extension for channel 15							

Diagnostic alarm: 1 = ON / 0 = OFF

Behavior at CPU-STOP 0 = Output Off / 1= Output On / 2 = Keep last value

Pulse extension: 0 = none / 1–255 = time (* 5ms)

8.2.4. Work method of pulse extension for DO high feature modules

Example 1: Output value is a short pulse.

When an increasing edge of the output signal is detected, the output is activated and kept active for the time t . When a falling edge is detected, the output is driven low until the expiration of t , regardless of the output signal.

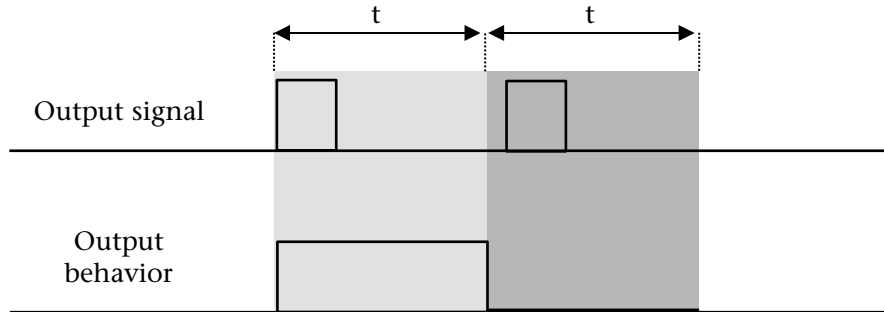

Example 2: Output signal is a series of short pulses.

On the detection of the first pulse, the output is activated and it stays active for the duration of t meaning that pulses are ignored. When a falling edge is detected the output is driven low. If the output signal becomes active during the extension of the logical 0 and remains active when t expires, it is detected and extended for the duration of t on the output.

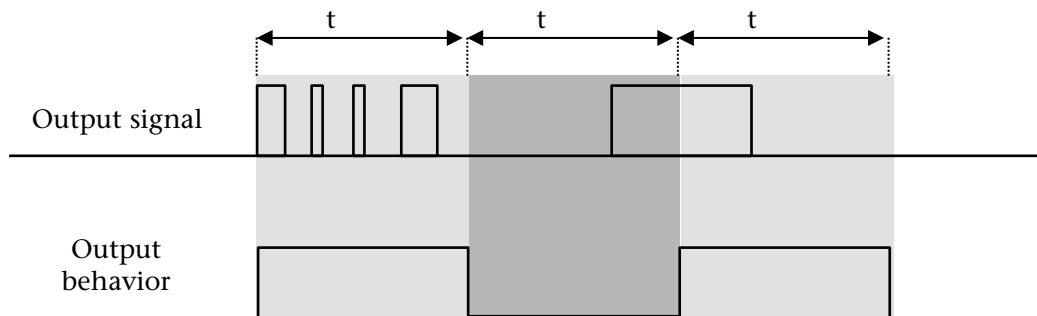

Example 3: Output signal is a pulse active beyond the duration of t .

The output is the exact copy of the output signal. When t expires and the falling edge is detected, the logical "0" is extended on the output.

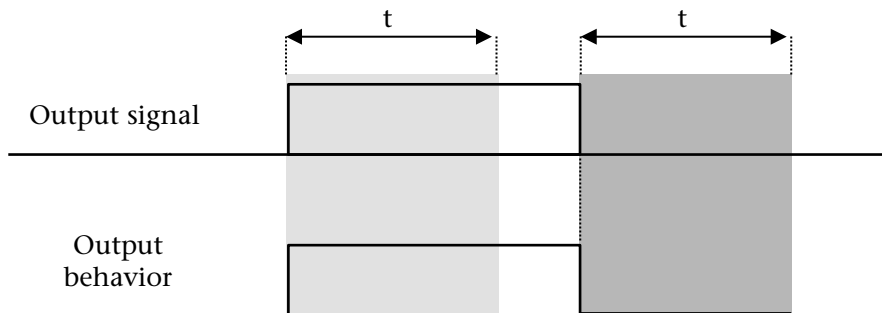

8.3. Analog Input Modules

8.3.1. 600-250-4AB01, AI 2x I, 0/4–20 mA, +-20 mA, 12-bit

Parameter set length: 12 bytes

Parameter	Byte	Bit 7	Bit 6	Bit 5	Bit 4	Bit 3	Bit 2	Bit 1	Bit 0
1	0	Diagnosis alarm	-	Overflow / underflow diagnosis	1	-	-	Format of values	
2	1	0	0	Channel 1 limit value alarm	Channel 0 limit value alarm	0	0	Channel 1 wire break detection	Channel 0 wire break detection
3	2	Channel 0 interf. frequency suppression			-	Channel 0 measuring range			
4	3	Channel 0 upper limit							
	4								
5	5	Channel 0 lower limit							
	6								
6	7	Channel 1 interf. frequency suppression			-	Channel 1 measuring range			
7	8	Channel 1 upper limit							
	9								
8	10	Channel 1 lower limit							
	11								

Diagnostic alarm: 1 = ON / 0 = OFF

Overflow / underflow diagnosis: 1 = ON / 0 = OFF

Format of values: 0 = Simatic S7; 1 = Simatic S5; 2 = INT16

Wire break detection (*only for 4 ... 20 mA*): 1 = ON / 0 = OFF

Interference frequency suppression: 0 = None / 1 = 10 Hz / 2 = 50 Hz / 3 = 60 Hz / 4 = 400 Hz

Measuring range: 0 = Disabled / 1 = ± 20 mA current / 2 = 0 ... 20 mA current / 3 = 4 ... 20 mA

Limit value alarm: 1 = ON / 0 = OFF

Upper / lower limit: 16-bit analog value (± 27648)

8.3.2. 600-250-4AD01, AI 4 x I, 0/4–20 mA, ±20 mA, 12-bit

Parameter set length: 22 bytes

Parameter	Byte	Bit 7	Bit 6	Bit 5	Bit 4	Bit 3	Bit 2	Bit 1	Bit 0
1	0	Diagnosis alarm	-	Overflow / underflow diagnosis	1	-	-	Format of values	
2	1	Channel 3 limit value alarm	Channel 2 limit value alarm	Channel 1 limit value alarm	Channel 0 limit value alarm	Channel 3 wire break detection	Channel 2 wire break detection	Channel 1 wire break detection	Channel 0 wire break detection
3	2	Channel 0 interf. frequency suppression			-	Channel 0 measuring range			
4	3	Channel 0 upper limit							
	4								
5	5	Channel 0 lower limit							
	6								
6	7	Channel 1 interf. frequency suppression			-	Channel 1 measuring range			
7	8	Channel 1 upper limit							
	9								
8	10	Channel 1 lower limit							
	11								
9	12	Channel 2 interf. frequency suppression			-	Channel 2 measuring range			
10	13	Channel 2 upper limit							
	14								
11	15	Channel 2 lower limit							
	16								
12	17	Channel 3 interf. frequency suppression			-	Channel 3 measuring range			
13	18	Channel 3 upper limit							
	19								
14	20	Channel 3 lower limit							
	21								

Diagnostic alarm: 1 = ON / 0 = OFF

Overflow / underflow diagnosis: 1 = ON / 0 = OFF

Format of values: 0 = Simatic S7; 1 = Simatic S5; 2 = INT16

Wire break detection (*only for 4 ... 20 mA*): 1 = ON / 0 = OFF

Interference frequency suppression: 0 = None / 1 = 10 Hz / 2 = 50 Hz / 3 = 60 Hz / 4 = 400 Hz

Measuring range: 0 = Disabled / 1 = ±20 mA current / 2 = 0–20 mA current / 3 = 4 ... 20 mA current

Limit value alarm: 1 = ON / 0 = OFF

Upper / lower limit: 16-bit analog value (±27648)

8.3.3. 600-250-7BB01, AI 2x I, 0/4–20 mA, +-20 mA, Iso., 16-bit

Parameter set length: 13 bytes

Parameter	Byte	Bit 7	Bit 6	Bit 5	Bit 4	Bit 3	Bit 2	Bit 1	Bit 0
1	0	Mode = 1							
2	1	Diagnosis alarm	-	Overflow / underflow diagnosis	1	-	-	Format of values	
3	2	0	0	Channel 1 limit value alarm	Channel 0 limit value alarm	0	0	Channel 1 wire break detection	Channel 0 wire break detection
4	3	Channel 0 interf. frequency suppression			-	Channel 0 measuring range			
5	4	Channel 0 upper limit							
	5								
6	6	Channel 0 lower limit							
	7								
7	8	Channel 1 interf. frequency suppression			-	Channel 1 measuring range			
8	9	Channel 1 upper limit							
	10								
9	11	Channel 1 lower limit							
	12								

Diagnostic alarm: 1 = ON / 0 = OFF

Overflow / underflow diagnosis: 1 = ON / 0 = OFF

Format of values: 0 = Simatic S7; 1 = Simatic S5; 2 = INT16

Wire break detection (*only for 4 ... 20 mA*): 1 = ON / 0 = OFF

Interference frequency suppression: 0 = None / 1 = 10 Hz / 2 = 50 Hz / 3 = 60 Hz / 4 = 400 Hz

Measuring range: 0 = Disabled / 1 = ±20 mA current / 2 = 0 ... 20 mA current / 3 = 4 ... 20 mA

Limit value alarm: 1 = ON / 0 = OFF

Upper / lower limit: 16-bit analog value (±27648)

8.3.4. 600-250-7BD01, AI 4x I, 0/4–20 mA, +-20 mA, Iso., 16-bit

Parameter set length: 23 bytes

Parameter	Byte	Bit 7	Bit 6	Bit 5	Bit 4	Bit 3	Bit 2	Bit 1	Bit 0
1	0	Mode = 1							
2	1	Diagnosis alarm	-	Overflow / underflow diagnosis	1	-	-	Format of values	
3	2	Channel 3 limit value alarm	Channel 2 limit value alarm	Channel 1 limit value alarm	Channel 0 limit value alarm	Channel 3 wire break detection	Channel 2 wire break detection	Channel 1 wire break detection	Channel 0 wire break detection
4	3	Channel 0 interf. frequency suppression			-	Channel 0 measuring range			
5	4	Channel 0 upper limit							
	5								
6	6	Channel 0 lower limit							
	7								
7	8	Channel 1 interf. frequency suppression			-	Channel 1 measuring range			
8	9	Channel 1 upper limit							
	10								
9	11	Channel 1 lower limit							
	12								
10	13	Channel 2 interf. frequency suppression			-	Channel 2 measuring range			
11	14	Channel 2 upper limit							
	15								
12	16	Channel 2 lower limit							
	17								
13	18	Channel 3 interf. frequency suppression			-	Channel 3 measuring range			
14	19	Channel 3 upper limit							
	20								
15	21	Channel 3 lower limit							
	22								

Diagnostic alarm: 1 = ON / 0 = OFF

Overflow / underflow diagnosis: 1 = ON / 0 = OFF

Format of values: 0 = Simatic S7; 1 = Simatic S5; 2 = INT16

Wire break detection (*only for 4 ... 20 mA*): 1 = ON / 0 = OFF

Interference frequency suppression: 0 = None / 1 = 10 Hz / 2 = 50 Hz / 3 = 60 Hz / 4 = 400 Hz

Measuring range: 0 = Disabled / 1 = ±20 mA current / 2 = 0–20 mA current / 3 = 4 ... 20 mA

Limit value alarm: 1 = ON / 0 = OFF

Upper / lower limit: 16-bit analog value (±27648)

8.3.5. 600-250-7BH21, AI 8x I, 0/4-20 mA, +-20 mA, Iso., 16-bit

Parameter set length: 44 bytes

Parameter	Byte	Bit 7	Bit 6	Bit 5	Bit 4	Bit 3	Bit 2	Bit 1	Bit 0
1	0	Mode = 1							
2	1	Diagnosis alarm	-	Overflow / underflow diagnosis	1	-	-	Format of values	
3	2	Channel 3 limit value alarm	Channel 2 limit value alarm	Channel 1 limit value alarm	Channel 0 limit value alarm	Channel 3 wire break detection	Channel 2 wire break detection	Channel 1 wire break detection	Channel 0 wire break detection
4	3	Channel 7 limit value alarm	Channel 6 limit value alarm	Channel 5 limit value alarm	Channel 4 limit value alarm	Channel 7 wire break detection	Channel 6 wire break detection	Channel 5 wire break detection	Channel 4 wire break detection
5	4	Channel 0 interf. frequency suppression			-	Channel 0 measuring range			
6	5	Channel 0 upper limit							
	6								
7	7	Channel 0 lower limit							
	8								
8	9	Channel 1 interf. frequency suppression			-	Channel 1 measuring range			
9	10	Channel 1 upper limit							
	11								
10	12	Channel 1 lower limit							
	13								
11	14	Channel 2 interf. frequency suppression			-	Channel 2 measuring range			
12	15	Channel 2 upper limit							
	16								
13	17	Channel 2 lower limit							
	18								
14	19	Channel 3 interf. frequency suppression			-	Channel 3 measuring range			
15	20	Channel 3 upper limit							
	21								
16	22	Channel 3 lower limit							
	23								
17	24	Channel 4 interf. frequency suppression			-	Channel 4 measuring range			
18	25	Channel 4 upper limit							
	26								
19	27	Channel 4 lower limit							
	28								
20	29	Channel 5 interf. frequency suppression			-	Channel 5 measuring range			
21	30	Channel 5 upper limit							
	31								
22	32	Channel 5 lower limit							
	33								
23	34	Channel 6 interf. frequency suppression			-	Channel 6 measuring range			
24	35	Channel 6 upper limit							
	36								
25	37	Channel 6 lower limit							
	38								
26	39	Channel 7 interf. frequency suppression			-	Channel 7 measuring range			
27	40	Channel 7 upper limit							
	41								
28	42	Channel 7 lower limit							
	43								

Diagnostic alarm: 1 = ON / 0 = OFF

Overflow / underflow diagnosis: 1 = ON / 0 = OFF

Format of values: 0 = Simatic S7; 1 = Simatic S5; 2 = INT16

Wire break detection (*only for 4 ... 20 mA*): 1 = ON / 0 = OFF

Interference frequency suppression: 0 = None / 1 = 10 Hz / 2 = 50 Hz / 3 = 60 Hz / 4 = 400 Hz

Measuring range: 0 = Disabled / 1 = ± 20 mA current / 2 = 0–20 mA current / 3 = 4 ... 20 mA

Limit value alarm: 1 = ON / 0 = OFF

Upper / lower limit: 16-bit analog value (± 27648)

8.3.6. 600-252-4AB01, AI 2 x U, ±10 V, 0–10 V, 1–5 V, 12-bit

Parameter set length: 12 bytes

Parameter	Byte	Bit 7	Bit 6	Bit 5	Bit 4	Bit 3	Bit 2	Bit 1	Bit 0
1	0	Diagnosis alarm	-	Overflow / underflow diagnosis	0	-	-	Format of values	
2	1	0	0	Channel 1 limit value alarm	Channel 0 limit value alarm	0	0	Channel 1 wire break detection	Channel 0 wire break detection
3	2	Channel 0 interf. frequency suppression			-	Channel 0 measuring range			
4	3	Channel 0 upper limit							
	4								
5	5	Channel 0 lower limit							
	6								
6	7	Channel 1 interf. frequency suppression			-	Channel 1 measuring range			
7	8	Channel 1 upper limit							
	9								
8	10	Channel 1 lower limit							
	11								

Diagnostic alarm: ON/OFF

Overflow / underflow diagnosis: ON/OFF

Format of values: 0 = Simatic S7; 1 = Simatic S5; 2 = INT16

Wire break detection (*only for 1 ... 5 V*): ON/OFF

Interference frequency suppression: 0 = OFF / 1 = 10 Hz / 2 = 50 Hz / 3 = 60 Hz / 4 = 400 Hz

Measuring ranges: 0 = Disabled / 1 = ±10 V voltage / 2 = 0 ... 10 V voltage /
3 = 1 ... 5 V voltage / 4 = ±5 V | ±2.5 V

Limit value alarm: ON/OFF

Upper / lower limit: 16-bit analog value (±27648)

8.3.7. 600-252-4AD01, AI 4 x U, ±10 V, 0–10 V, 1–5 V, 12-bit

Parameter set length: 22 bytes

Parameter	Byte	Bit 7	Bit 6	Bit 5	Bit 4	Bit 3	Bit 2	Bit 1	Bit 0
1	0	Diagnosis alarm	-	Overflow / underflow diagnosis	0	-	-	Format of values	
2	1	Channel 3 limit value alarm	Channel 2 limit value alarm	Channel 1 limit value alarm	Channel 0 limit value alarm	Channel 3 wire break detection	Channel 2 wire break detection	Channel 1 wire break detection	Channel 0 wire break detection
3	2	Channel 0 interf. frequency suppression			-	Channel 0 measuring range			
4	3	Channel 0 upper limit							
	4								
5	5	Channel 0 lower limit							
	6								
6	7	Channel 1 interf. frequency suppression			-	Channel 1 measuring range			
7	8	Channel 1 upper limit							
	9								
8	10	Channel 1 lower limit							
	11								
9	12	Channel 2 interf. frequency suppression			-	Channel 2 measuring range			
10	13	Channel 2 upper limit							
	14								
11	15	Channel 2 lower limit							
	16								
12	17	Channel 3 interf. frequency suppression			-	Channel 3 measuring range			
13	18	Channel 3 upper limit							
	19								
14	20	Channel 3 lower limit							
	21								

Diagnostic alarm: 1 = ON / 0 = OFF

Overflow / underflow diagnosis: 1 = ON / 0 = OFF

Format of values: 0 = Simatic S7; 1 = Simatic S5; 2 = INT16

Wire break detection (*only for 1 ... 5 V*): ON/OFF

Interference frequency suppression: 0 = None / 1 = 10 Hz / 2 = 50 Hz / 3 = 60 Hz / 4 = 400 Hz

Measuring range: 0 = Disabled / 1 = ±10 V voltage / 2 = 0 ... 10 V voltage /
3 = 1 ... 5 V voltage / 4 = ±5 V / 5 = ±2.5 V

Limit value alarm: 1 = ON / 0 = OFF

Upper / lower limit: 16-bit analog value (±27648)

8.3.8. 600-252-7BB01, AI 2x U, +-10 V, 0-10 V, 1-5 V, Iso., 16-bit

Parameter set length: 13 bytes

Parameter	Byte	Bit 7	Bit 6	Bit 5	Bit 4	Bit 3	Bit 2	Bit 1	Bit 0
1	0	Mode = 10							
2	1	Diagnosis alarm	-	Overflow / underflow diagnosis	0	-	-	Format of values	
3	2	0	0	Channel 1 limit value alarm	Channel 0 limit value alarm	0	0	Channel 1 wire break detection	Channel 0 wire break detection
4	3	Channel 0 interf. frequency suppression			-	Channel 0 measuring range			
5	4	Channel 0 upper limit							
	5								
6	6	Channel 0 lower limit							
	7								
7	8	Channel 1 interf. frequency suppression			-	Channel 1 measuring range			
8	9	Channel 1 upper limit							
	10								
9	11	Channel 1 lower limit							
	12								

Diagnostic alarm: ON/OFF

Overflow / underflow diagnosis: ON/OFF

Format of values: 0 = Simatic S7; 1 = Simatic S5; 2 = INT16

Wire break detection (*only for 1 ... 5 V*): ON/OFF

Interference frequency suppression: 0 = OFF / 1 = 10 Hz / 2 = 50 Hz / 3 = 60 Hz / 4 = 400 Hz

Measuring ranges: 0 = Disabled / 1 = ±10 V voltage / 2 = 0 ... 10 V voltage /
3 = 1 ... 5 V voltage / 4 = ±5 V | ±2.5 V

Limit value alarm: ON/OFF

Upper / lower limit: 16-bit analog value (±27648)

8.3.9. 600-252-7BD01, AI 4x U, +10 V, 0–10 V, 1–5 V, Iso., 16-bit

Parameter set length: 23 bytes

Parameter	Byte	Bit 7	Bit 6	Bit 5	Bit 4	Bit 3	Bit 2	Bit 1	Bit 0
1	0	Mode = 10							
2	1	Diagnosis alarm	-	Overflow / underflow diagnosis	0	-	-	Format of values	
3	2	Channel 3 limit value alarm	Channel 2 limit value alarm	Channel 1 limit value alarm	Channel 0 limit value alarm	Channel 3 wire break detection	Channel 2 wire break detection	Channel 1 wire break detection	Channel 0 wire break detection
4	3	Channel 0 interf. frequency suppression			-	Channel 0 measuring range			
5	4	Channel 0 upper limit							
	5								
6	6	Channel 0 lower limit							
	7								
7	8	Channel 1 interf. frequency suppression			-	Channel 1 measuring range			
8	9	Channel 1 upper limit							
	10								
9	11	Channel 1 lower limit							
	12								
10	13	Channel 2 interf. frequency suppression			-	Channel 2 measuring range			
11	14	Channel 2 upper limit							
	15								
12	16	Channel 2 lower limit							
	17								
13	18	Channel 3 interf. frequency suppression			-	Channel 3 measuring range			
14	19	Channel 3 upper limit							
	20								
15	21	Channel 3 lower limit							
	22								

Diagnostic alarm: 1 = ON / 0 = OFF

Overflow / underflow diagnosis: 1 = ON / 0 = OFF

Format of values: 0 = Simatic S7; 1 = Simatic S5; 2 = INT16

Wire break detection (*only for 1 ... 5 V*): ON/OFF

Interference frequency suppression: 0 = None / 1 = 10 Hz / 2 = 50 Hz / 3 = 60 Hz / 4 = 400 Hz

Measuring range: 0 = Disabled / 1 = ±10 V voltage / 2 = 0 ... 10 V voltage /
3 = 1 ... 5 V voltage / 4 = ±5 V / 5 = ±2.5 V

Limit value alarm: 1 = ON / 0 = OFF

Upper / lower limit: 16-bit analog value (±27648)

8.3.10. 600-252-7BH21, AI 8x U, +-10 V, 0–10 V, 1–5 V, Iso., 16-bit

Parameter set length: 44 bytes

Parameter	Byte	Bit 7	Bit 6	Bit 5	Bit 4	Bit 3	Bit 2	Bit 1	Bit 0
1	0	Mode = 10							
2	1	Diagnosis alarm	-	Overflow / underflow diagnosis	0	-	-	Format of values	
3	2	Channel 3 limit value alarm	Channel 2 limit value alarm	Channel 1 limit value alarm	Channel 0 limit value alarm	Channel 3 wire break detection	Channel 2 wire break detection	Channel 1 wire break detection	Channel 0 wire break detection
4	3	Channel 7 limit value alarm	Channel 6 limit value alarm	Channel 5 limit value alarm	Channel 4 limit value alarm	Channel 7 wire break detection	Channel 6 wire break detection	Channel 5 wire break detection	Channel 4 wire break detection
5	4	Channel 0 interf. frequency suppression			-	Channel 0 measuring range			
6	5	Channel 0 upper limit							
	6								
7	7	Channel 0 lower limit							
	8								
8	9	Channel 1 interf. frequency suppression			-	Channel 1 measuring range			
9	10	Channel 1 upper limit							
	11								
10	12	Channel 1 lower limit							
	13								
11	14	Channel 2 interf. frequency suppression			-	Channel 2 measuring range			
12	15	Channel 2 upper limit							
	16								
13	17	Channel 2 lower limit							
	18								
14	19	Channel 3 interf. frequency suppression			-	Channel 3 measuring range			
15	20	Channel 3 upper limit							
	21								
16	22	Channel 3 lower limit							
	23								
17	24	Channel 4 interf. frequency suppression			-	Channel 4 measuring range			
18	25	Channel 4 upper limit							
	26								
19	27	Channel 4 lower limit							
	28								
20	29	Channel 5 interf. frequency suppression			-	Channel 5 measuring range			
21	30	Channel 5 upper limit							
	31								
22	32	Channel 5 lower limit							
	33								
23	34	Channel 6 interf. frequency suppression			-	Channel 6 measuring range			
24	35	Channel 6 upper limit							
	36								
25	37	Channel 6 lower limit							
	38								
26	39	Channel 7 interf. frequency suppression			-	Channel 7 measuring range			
27	40	Channel 7 upper limit							
	41								
28	42	Channel 7 lower limit							
	43								

Diagnostic alarm: 1 = ON / 0 = OFF

Overflow / underflow diagnosis: 1 = ON / 0 = OFF

Format of values: 0 = Simatic S7; 1 = Simatic S5; 2 = INT16

Wire break detection (*only for 1 ... 5 V*): ON/OFF

Interference frequency suppression: 0 = None / 1 = 10 Hz / 2 = 50 Hz / 3 = 60 Hz / 4 = 400 Hz

Measuring range: 0 = Disabled / 1 = ± 10 V voltage / 2 = 0 ... 10 V voltage /
3 = 1 ... 5 V voltage / 4 = ± 5 V / 5 = ± 2.5 V

Limit value alarm: 1 = ON / 0 = OFF

Upper / lower limit: 16-bit analog value (± 27648)

8.3.11. 600-252-4CB01, AI 2x U, +-24 V, 0–24 V, 12-bit

Parameter set length: 12 bytes

Parameter	Byte	Bit 7	Bit 6	Bit 5	Bit 4	Bit 3	Bit 2	Bit 1	Bit 0
1	0	Diagnosis alarm	-	Overflow / underflow diagnosis	0	-	-	Format of values	
2	1	0	0	Channel 1 limit value alarm	Channel 0 limit value alarm	0	0	0	0
3	2	Channel 0 interf. frequency suppression			-	Channel 0 measuring range			
4	3	Channel 0 upper limit							
	4								
5	5	Channel 0 lower limit							
	6								
6	7	Channel 1 interf. frequency suppression			-	Channel 1 measuring range			
7	8	Channel 1 upper limit							
	9								
8	10	Channel 1 lower limit							
	11								

Diagnostic alarm: ON/OFF

Overflow / underflow diagnosis: ON/OFF

Format of values: 0 = Simatic S7; 1 = Simatic S5

Interference frequency suppression: 0 = OFF / 1 = 10 Hz / 2 = 50 Hz / 3 = 60 Hz / 4 = 400 Hz

Measuring ranges: 0 = Disabled / 1 = ±24 V voltage / 2 = 0 ... 24 V

Limit value alarm: ON/OFF

Upper / lower limit: 16-bit analog value (±27648)

8.3.13. 600-252-4CD01, AI 4x U, +-24 V, 0–24 V, 12-bit

Parameter set length: 22 bytes

Parameter	Byte	Bit 7	Bit 6	Bit 5	Bit 4	Bit 3	Bit 2	Bit 1	Bit 0
1	0	Diagnosis alarm	-	Overflow / underflow diagnosis	0	-	-	Format of values	
2	1	Channel 3 limit value alarm	Channel 2 limit value alarm	Channel 1 limit value alarm	Channel 0 limit value alarm	0	0	0	0
3	2	Channel 0 interf. frequency suppression			-	Channel 0 measuring range			
4	3	Channel 0 upper limit							
	4								
5	5	Channel 0 lower limit							
	6								
6	7	Channel 1 interf. frequency suppression			-	Channel 1 measuring range			
7	8	Channel 1 upper limit							
	9								
8	10	Channel 1 lower limit							
	11								
9	12	Channel 2 interf. frequency suppression			-	Channel 2 measuring range			
10	13	Channel 2 upper limit							
	14								
11	15	Channel 2 lower limit							
	16								
12	17	Channel 3 interf. frequency suppression			-	Channel 3 measuring range			
13	18	Channel 3 upper limit							
	19								
14	20	Channel 3 lower limit							
	21								

Diagnostic alarm: 1 = ON / 0 = OFF

Overflow / underflow diagnosis: 1 = ON / 0 = OFF

Format of values: 0 = Simatic S7; 1 = Simatic S5

Interference frequency suppression: 0 = None / 1 = 10 Hz / 2 = 50 Hz / 3 = 60 Hz / 4 = 400 Hz

Measuring range: 0 = Disabled / 1 = ±24 V voltage / 2 = 0 ... 24 V

Limit value alarm: 1 = ON / 0 = OFF

Upper / lower limit: 16-bit analog value (±27648)

8.3.14. 600-252-7DD01, AI 4x U, +-100 V, 0-100 V, Iso., 16-bit

Parameter set length: 23 bytes

Parameter	Byte	Bit 7	Bit 6	Bit 5	Bit 4	Bit 3	Bit 2	Bit 1	Bit 0
1	0	Mode = 10							
2	1	Diagnosis alarm	-	Overflow / underflow diagnosis	0	-	-	Format of values	
3	2	Channel 3 limit value alarm	Channel 2 limit value alarm	Channel 1 limit value alarm	Channel 0 limit value alarm	0	0	0	0
4	3	Channel 0 interf. frequency suppression			-	Channel 0 measuring range			
5	4	Channel 0 upper limit							
	5								
6	6	Channel 0 lower limit							
	7								
7	8	Channel 1 interf. frequency suppression			-	Channel 1 measuring range			
8	9	Channel 1 upper limit							
	10								
9	11	Channel 1 lower limit							
	12								
10	13	Channel 2 interf. frequency suppression			-	Channel 2 measuring range			
11	14	Channel 2 upper limit							
	15								
12	16	Channel 2 lower limit							
	17								
13	18	Channel 3 interf. frequency suppression			-	Channel 3 measuring range			
14	19	Channel 3 upper limit							
	20								
15	21	Channel 3 lower limit							
	22								

Diagnostic alarm: 1 = ON / 0 = OFF

Overflow / underflow diagnosis: 1 = ON / 0 = OFF

Format of values: 0 = Simatic S7; 1 = Simatic S5; 2 = INT16

Interference frequency suppression: 0 = None / 1 = 10 Hz / 2 = 50 Hz / 3 = 60 Hz / 4 = 400 Hz

Measuring range: 0 = Disabled / 1 = ±100 V voltage / 2 = 0 ... 100 V voltage

Limit value alarm: 1 = ON / 0 = OFF

Upper / lower limit: 16-bit analog value (±27648)

8.3.15. 600-252-7DH21, AI 8x U, +-100 V, 0-100 V, Iso., 16-bit

Parameter set length: 44 bytes

Parameter	Byte	Bit 7	Bit 6	Bit 5	Bit 4	Bit 3	Bit 2	Bit 1	Bit 0
1	0	Mode = 10							
2	1	Diagnosis alarm	-	Overflow / underflow diagnosis	0	-	-	Format of values	
3	2	Channel 3 limit value alarm	Channel 2 limit value alarm	Channel 1 limit value alarm	Channel 0 limit value alarm	0	0	0	0
4	3	Channel 7 limit value alarm	Channel 6 limit value alarm	Channel 5 limit value alarm	Channel 4 limit value alarm	0	0	0	0
5	4	Channel 0 interf. frequency suppression			-	Channel 0 measuring range			
6	5	Channel 0 upper limit							
	6								
7	7	Channel 0 lower limit							
	8								
8	9	Channel 1 interf. frequency suppression			-	Channel 1 measuring range			
9	10	Channel 1 upper limit							
	11								
10	12	Channel 1 lower limit							
	13								
11	14	Channel 2 interf. frequency suppression			-	Channel 2 measuring range			
12	15	Channel 2 upper limit							
	16								
13	17	Channel 2 lower limit							
	18								
14	19	Channel 3 interf. frequency suppression			-	Channel 3 measuring range			
15	20	Channel 3 upper limit							
	21								
16	22	Channel 3 lower limit							
	23								
17	24	Channel 4 interf. frequency suppression			-	Channel 4 measuring range			
18	25	Channel 4 upper limit							
	26								
19	27	Channel 4 lower limit							
	28								
20	29	Channel 5 interf. frequency suppression			-	Channel 5 measuring range			
21	30	Channel 5 upper limit							
	31								
22	32	Channel 5 lower limit							
	33								
23	34	Channel 6 interf. frequency suppression			-	Channel 6 measuring range			
24	35	Channel 6 upper limit							
	36								
25	37	Channel 6 lower limit							
	38								
26	39	Channel 7 interf. frequency suppression			-	Channel 7 measuring range			
27	40	Channel 7 upper limit							
	41								
28	42	Channel 7 lower limit							
	43								

Diagnostic alarm: 1 = ON / 0 = OFF

Overflow / underflow diagnosis: 1 = ON / 0 = OFF

Format of values: 0 = Simatic S7; 1 = Simatic S5; 2 = INT16

Interference frequency suppression: 0 = None / 1 = 10 Hz / 2 = 50 Hz / 3 = 60 Hz / 4 = 400 Hz

Measuring range: 0 = Disabled / 1 = ± 100 V voltage / 2 = 0 ... 100 V voltage

Limit value alarm: 1 = ON / 0 = OFF

Upper / lower limit: 16-bit analog value (± 27648)

8.3.16. 600-253-4AB01, AI 1/2 x R, RTD, 16-bit, 2/3/4-wire

Parameter set length: 14 bytes

Parameter	Byte	Bit 7	Bit 6	Bit 5	Bit 4	Bit 3	Bit 2	Bit 1	Bit 0
1	0	Diagnosis alarm	-	Overflow / underflow diagnosis	0	Temperature unit		0 0	
2	1	-	-	Channel 1 limit value alarm	Channel 0 limit value alarm	-	-	Channel 1 wire break detection	Channel 0 wire break detection
3	2	Channel 0 interf. frequency suppression			-	Channel 0 measuring range			
4	3	-	-	-	-	-	Channel 0 sensor type		
5	4	Channel 0 upper limit							
	5								
6	6	Channel 0 lower limit							
	7								
7	8	Channel 1 interf. frequency suppression			-	Channel 1 measuring range			
8	9	-	-	-	-	-	Channel 0 sensor type 2-wire or disabled		
9	10	Channel 1 upper limit							
	11								
10	12	Channel 1 lower limit							
	13								

Diagnostic alarm: 1 = ON / 0 = OFF

Overflow / underflow diagnosis: 1 = ON / 0 = OFF

Temperature unit: 0 = °C x 10 / 1 = °F x 10 / 2 = K x 10 (for all temperature measuring ranges)

Wire break detection: ON/OFF

Interference frequency suppression: 0 = None / 1 = 10 Hz / 2 = 50 Hz / 3 = 60 Hz / 4 = 400 Hz

Measuring range: 1 = PT100 (-240 ... 1000°C) /
 2 = PT1000 (-240 ... 1000°C) /
 3 = Ni100 (-110 ... 295°C) /
 4 = Ni1000 (-110 ... 295°C) /
 5 = LGNi1000 (-110 ... 295°C) /
 6 = 0 ... 150R /
 7 = 0 ... 300R /
 8 = 0 ... 600R /
 9 = 0 ... 3000R /
 10 = 0 ... 6000R
 11 = PT100 climate (as of FW V1.06)
 12 = PT1000 climate (as of FW V1.06)

Sensor type: 0 = disabled / 1 = 2-wire / 2 = 3-wire / 3 = 4-wire
 → 3-wire and 4-wire can be selected only on channel 0!

Limit value alarm: 1 = ON / 0 = OFF

Upper / lower limit: 16-bit analog value (±27648)

8.3.17. 600-253-4AD01, AI 2/4x R, RTD, 16-bit, 2/3/4-wire

Parameter set length: 26 bytes

Parameter	Byte	Bit 7	Bit 6	Bit 5	Bit 4	Bit 3	Bit 2	Bit 1	Bit 0
1	0	Diagnosis alarm	-	Overflow / underflow diagnosis	0	Temperature unit		0 0	
2	1	Channel 3 limit value alarm	Channel 2 limit value alarm	Channel 1 limit value alarm	Channel 0 limit value alarm	Channel 3 wire break detection	Channel 2 wire break detection	Channel 1 wire break detection	Channel 0 wire break detection
3	2	Channel 0 interf. frequency suppression			-	Channel 0 measuring range			
4	3	-	-	-	-	-	Channel 0 sensor type		
5	4	Channel 0 upper limit							
	5								
6	6	Channel 0 lower limit							
	7								
7	8	Channel 1 interf. frequency suppression			-	Channel 1 measuring range			
8	9	-	-	-	-	-	Channel 1 sensor type <i>2-wire or disabled</i>		
9	10	Channel 1 upper limit							
	11								
10	12	Channel 1 lower limit							
	13								
11	14	Channel 2 interf. frequency suppression			-	Channel 2 measuring range			
12	15	-	-	-	-	-	Channel 2 sensor type		
13	16	Channel 2 upper limit							
	17								
14	18	Channel 2 lower limit							
	19								
15	20	Channel 3 interf. frequency suppression			-	Channel 3 measuring range			
16	21	-	-	-	-	-	Channel 3 sensor type <i>2-wire or disabled</i>		
17	22	Channel 3 upper limit							
	23								
18	24	Channel 3 lower limit							
	25								

Diagnostic alarm: 1 = ON / 0 = OFF

Overflow / underflow diagnosis: 1 = ON / 0 = OFF

Temperature unit: 0 = °C x 10 / 1 = °F x 10 / 2 = K x 10 (for all temperature measuring ranges)

Wire break detection: ON/OFF

Interference frequency suppression: 0 = None / 1 = 10 Hz / 2 = 50 Hz / 3 = 60 Hz / 4 = 400 Hz

Measuring range: 1 = PT100 (-240 ... 1000°C) /
 2 = PT1000 (-240 ... 1000°C) /
 3 = Ni100 (-110 ... 295°C) /
 4 = Ni1000 (-110 ... 295°C) /
 5 = LGNi1000 (-110 ... 295°C) /
 6 = 0 ... 150R /
 7 = 0 ... 300R /
 8 = 0 ... 600R /
 9 = 0 ... 3000R /
 10 = 0 ... 6000R
 11 = PT100 climate (as of FW V1.06)
 12 = PT1000 climate (as of FW V1.06)

Sensor type: 0 = disabled / 1 = 2-wire / 2 = 3-wire / 3 = 4-wire
 → 3-wire and 4-wire can be selected only on channel 0 and channel 2!

Limit value alarm: 1 = ON / 0 = OFF

Upper / lower limit: 16-bit analog value (± 27648)

8.3.18. 600-254-4AB01, AI 2 x TC, 16-bit

8.3.19. 600-254-4AB02, AI 2 x TC, Iso., 16-bit

Parameter set length: 14 bytes

Parameter	Byte	Bit 7	Bit 6	Bit 5	Bit 4	Bit 3	Bit 2	Bit 1	Bit 0
1	0	Diagnosis alarm	-	Overflow / underflow diagnosis	-	Temperature unit		Format of values	
2	1	0	0	Channel 1 limit value alarm	Channel 0 limit value alarm	0	0	Channel 1 wire break detection	Channel 0 wire break detection
3	2	Channel 0 interf. frequency suppression			-	Channel 0 measuring range			
4	3	-	-	-	-	-	Channel 0 temperature compensation		
5	4	Channel 0 upper limit							
	5								
6	6	Channel 0 lower limit							
	7								
7	8	Channel 1 interf. frequency suppression			-	Channel 1 measuring range			
8	9	-	-	-	-	-	Channel 1 temperature compensation		
9	10	Channel 1 upper limit							
	11								
10	12	Channel 1 lower limit							
	13								

Diagnostic alarm: 1 = ON / 0 = OFF

Overflow / underflow diagnosis: 1 = ON / 0 = OFF

Representation values: 0 = Simatic S7 / 1 = Simatic S5 (for +-80 mV only)

Temperature unit: 0 = °C x 10 / 1 = °F x 10 / 2 = K x 10 (for all temperature measuring ranges)

Interference frequency suppression: 0 = None / 1 = 10 Hz / 2 = 50 Hz / 3 = 60 Hz / 4 = 400 Hz

Measuring range: 0 = deactivated

1 = -80mV ... +80mV

2 = TC_E (-270°C ... 990°C)

3 = TC_J (-210°C ... 1200°C)

4 = TC_K (-270°C ... 1380°C)

5 = TC_N (-270°C ... 1320°C)

6 = TC_R (-50°C ... 1775°C)

7 = TC_S (-50°C ... 1775°C)

8 = TC_T (-270°C ... 405°C)

9 = TC_B (0°C ... 1800°C)

10 = TC_C (0°C ... 2320°C)

11 = TC_L (0°C ... 900°C)

Temperature compensation: 1 = Internal / 2 = External or none / 3 = Via process data outputs

Limit value alarm: 1 = ON / 0 = OFF

Upper / lower limit: 16-bit analog value (±27648)

8.3.20. 600-254-4AD01, AI 4 x TC, 16-bit

8.3.21. 600-254-4AD02, AI 4 x TC, Iso., 16-bit

Parameter set length: 26 bytes

Parameter	Byte	Bit 7	Bit 6	Bit 5	Bit 4	Bit 3	Bit 2	Bit 1	Bit 0
1	0	Diagnosis alarm	-	Overflow / underflow diagnosis	-	Temperature unit		Format of values	
2	1	Channel 3 limit value alarm	Channel 2 limit value alarm	Channel 1 limit value alarm	Channel 0 limit value alarm	Channel 3 wire break detection	Channel 2 wire break detection	Channel 1 wire break detection	Channel 0 wire break detection
3	2	Channel 0 interf. frequency suppression			-	Channel 0 measuring range			
4	3	-	-	-	-	-	Channel 0 temperature compensation		
5	4	Channel 0 upper limit							
	5								
6	6	Channel 0 lower limit							
	7								
7	8	Channel 1 interf. frequency suppression			-	Channel 1 measuring range			
8	9	-	-	-	-	-	Channel 1 temperature compensation		
9	10	Channel 1 upper limit							
	11								
10	12	Channel 1 lower limit							
	13								
11	14	Channel 2 interf. frequency suppression			-	Channel 2 measuring range			
12	15	-	-	-	-	-	Channel 2 temperature compensation		
13	16	Channel 2 upper limit							
	17								
14	18	Channel 2 lower limit							
	19								
15	20	Channel 3 interf. frequency suppression			-	Channel 3 measuring range			
16	21	-	-	-	-	-	Channel 3 temperature compensation		
17	22	Channel 3 upper limit							
	23								
18	24	Channel 3 lower limit							
	25								

Diagnostic alarm: 1 = ON / 0 = OFF

Overflow / underflow diagnosis: 1 = ON / 0 = OFF

Representation values: 0 = Simatic S7 / 1 = Simatic S5 (for +/-80 mV only)

Temperature unit: 0 = °C x 10 / 1 = °F x 10 / 2 = K x 10 (for all temperature measuring ranges)

Interference frequency suppression: 0 = None / 1 = 10 Hz / 2 = 50 Hz / 3 = 60 Hz / 4 = 400 Hz

Measuring range: 0 = deactivated

1 = -80mV ... +80mV

2 = TC_E (-270°C ... 990°C)

3 = TC_J (-210°C ... 1200°C)

4 = TC_K (-270°C ... 1380°C)

5 = TC_N (-270°C ... 1320°C)

6 = TC_R (-50°C ... 1775°C)

7 = TC_S (-50°C ... 1775°C)

8 = TC_T (-270°C ... 405°C)

9 = TC_B (0°C ... 1800°C)

10 = TC_C (0°C ... 2320°C)

11 = TC_L (0°C ... 900°C)

Temperature compensation: 1 = Internal / 2 = External or none / 3 = Via process data outputs

Limit value alarm: 1 = ON / 0 = OFF

Upper / lower limit: 16-bit analog value (±27648)

8.3.22. 600-254-4AH22, AI 8 x TC, Iso., 16-bit

Parameter set length: 51 bytes

Parameter	Byte	Bit 7	Bit 6	Bit 5	Bit 4	Bit 3	Bit 2	Bit 1	Bit 0
1	0	Diagnosis alarm	-	Overflow / underflow diagnosis	-	Temperature unit		Format of values	
2	1	Channel 3 limit value alarm	Channel 2 limit value alarm	Channel 1 limit value alarm	Channel 0 limit value alarm	Channel 3 wire break detection	Channel 2 wire break detection	Channel 1 wire break detection	Channel 0 wire break detection
3	2	Channel 3 limit value alarm	Channel 2 limit value alarm	Channel 1 limit value alarm	Channel 0 limit value alarm	Channel 7 wire break detection	Channel 6 wire break detection	Channel 5 wire break detection	Channel 4 wire break detection
4	3	Channel 0 interf. frequency suppression			-	Channel 0 measuring range			
5	4	-	-	-	-	-	Channel 0 temperature compensation		
6	5	Channel 0 upper limit							
	6								
7	7	Channel 0 lower limit							
	8								
8	9	Channel 1 interf. frequency suppression			-	Channel 1 measuring range			
9	10	-	-	-	-	-	Channel 1 temperature compensation		
10	11	Channel 1 upper limit							
	12								
11	13	Channel 1 lower limit							
	14								
12	15	Channel 2 interf. frequency suppression			-	Channel 2 measuring range			
13	16	-	-	-	-	-	Channel 2 temperature compensation		
14	17	Channel 2 upper limit							
	18								
15	19	Channel 2 lower limit							
	20								
16	21	Channel 3 interf. frequency suppression			-	Channel 3 measuring range			
17	22	-	-	-	-	-	Channel 3 temperature compensation		
18	23	Channel 3 upper limit							
	24								
19	25	Channel 3 lower limit							
	26								
20	27	Channel 4 interf. frequency suppression			-	Channel 4 measuring range			
21	28	-	-	-	-	-	Channel 4 temperature compensation		
22	29	Channel 4 upper limit							
	30								
23	31	Channel 4 lower limit							
	32								
24	33	Channel 5 interf. frequency suppression			-	Channel 5 measuring range			
25	34	-	-	-	-	-	Channel 5 temperature compensation		
26	35	Channel 5 upper limit							
	36								
27	37	Channel 5 lower limit							
	38								
28	39	Channel 6 interf. frequency suppression			-	Channel 6 measuring range			
29	40	-	-	-	-	-	Channel 6 temperature compensation		
30	41	Channel 6 upper limit							
	42								
31	43	Channel 6 lower limit							
	44								
32	45	Channel 7 interf. frequency suppression			-	Channel 7 measuring range			
33	46	-	-	-	-	-	Channel 7 temperature compensation		
34	47	Channel 7 upper limit							
	48								
35	49	Channel 7 lower limit							
	50								

Diagnostic alarm: 1 = ON / 0 = OFF

Overflow / underflow diagnosis: 1 = ON / 0 = OFF

Representation values: 0 = Simatic S7 / 1 = Simatic S5 (for +-80 mV only)

Temperature unit: 0 = °C x 10 / 1 = °F x 10 / 2 = K x 10 (for all temperature measuring ranges)

Interference frequency suppression: 0 = None / 1 = 10 Hz / 2 = 50 Hz / 3 = 60 Hz / 4 = 400 Hz

Measuring range: 0 = deactivated

1 = -80mV ... +80mV

2 = TC_E (-270°C ... 990°C)

3 = TC_J (-210°C ... 1200°C)

4 = TC_K (-270°C ... 1380°C)

5 = TC_N (-270°C ... 1320°C)

6 = TC_R (-50°C ... 1775°C)

7 = TC_S (-50°C ... 1775°C)

8 = TC_T (-270°C ... 405°C)

9 = TC_B (0°C ... 1800°C)

10 = TC_C (0°C ... 2320°C)

11 = TC_L (0°C ... 900°C)

Temperature compensation: 1= Internal / 2 = External or none / 3 = Via process data outputs

Limit value alarm: 1 = ON / 0 = OFF

Upper / lower limit: 16-bit analog value (±27648)

8.4. Analog Output Modules

8.4.1. 600-260-4AB01, AO 2 x I, 0/4–20 mA, 12-bit

Parameter set length: 7 bytes

Parameter	Byte	Bit 7	Bit 6	Bit 5	Bit 4	Bit 3	Bit 2	Bit 1	Bit 0
1	0	Diagnosis alarm	-	-	1	-	-	Format of values	
2	1	Channel 0 wire break detection	Channel 0 behavior at CPU-STOP			Channel 0 output range			
3	2	Channel 0 substitute value							
	3								
4	4	Channel 1 wire break detection	Channel 1 behavior at CPU-STOP			Channel 1 output range			
5	5	Channel 1 substitute value							
	6								

Diagnostic alarm: 1 = ON / 0 = OFF

Format of values: 0 = Simatic S7; 1 = Simatic S5; 2 = INT16

Wire break detection: 1 = On/ 0 = Off

Output ranges: 0 = Disabled / 1 = 0–20 mA current / 2 = 4 ... 20 mA current

Behavior at CPU-STOP: 0 = Outputs de-energized / 1= Retain last value / 2 = Apply substitute value

Substitute value: 16-bit analog value (± 27648)

8.4.2. 600-260-4AD01, AO 4 x I, 0/4–20 mA, 12-bit

Parameter set length: 13 bytes

Parameter	Byte	Bit 7	Bit 6	Bit 5	Bit 4	Bit 3	Bit 2	Bit 1	Bit 0
1	0	Diagnosis alarm	-	-	1	-	-	Format of values	
2	1	Channel 0 wire break detection	Channel 0 behavior at CPU-STOP			Channel 0 output range			
3	2	Channel 0 substitute value							
	3								
4	4	Channel 1 wire break detection	Channel 1 behavior at CPU-STOP			Channel 1 output range			
5	5	Channel 1 substitute value							
	6								
6	7	Channel 2 wire break detection	Channel 2 behavior at CPU-STOP			Channel 2 output range			
7	8	Channel 2 substitute value							
	9								
8	10	Channel 3 wire break detection	Channel 3 behavior at CPU-STOP			Channel 3 output range			
9	11	Channel 3 substitute value							
	12								

Diagnostic alarm: 1 = ON / 0 = OFF

Format of values: 0 = Simatic S7; 1 = Simatic S5; 2 = INT16

Wire break detection: 1 = On/ 0 = Off

Output ranges: 0 = deactivated / 1 = 0 ... 20 mA current/
2 = 4 ... 20 mA current

Behavior at CPU-STOP 0 = Outputs de-energized / 1= Retain last value / 2 = Apply substitute value

Substitute value: 16-bit analog value (±27648)

8.4.3. 600-261-4AB01, AO 2x U, +-10 V, 0-10 V, 1-5 V, 12-bit

Parameter set length: 7 bytes

Parameter	Byte	Bit 7	Bit 6	Bit 5	Bit 4	Bit 3	Bit 2	Bit 1	Bit 0
1	0	Diagnosis alarm	-	-	0	-	-	Format of values	
2	1	0	Channel 0 behavior at CPU-STOP			Channel 0 output range			
3	2	Channel 0 substitute value							
	3								
4	4	0	Channel 1 behavior at CPU-STOP			Channel 1 output range			
5	5	Channel 1 substitute value							
	6								

Diagnostic alarm: 1 = ON / 0 = OFF

Format of values: 0 = Simatic S7; 1 = Simatic S5; 2 = INT16

Output range: 0 = Disabled / 1 = ±10 V voltage / 2 = 0 ... 10 V voltage /
3 = 1 ... 5 V voltage

Behavior at CPU-STOP 0 = Outputs de-energized / 1 = Retain last value / 2 = Apply substitute value

Substitute value: 16-bit analog value (±27648)

8.4.4. 600-261-4AD01, AO 4 x U, ±10 V, 0–10 V, 1–5 V, 12-bit

Parameter set length: 13 bytes

Parameter	Byte	Bit 7	Bit 6	Bit 5	Bit 4	Bit 3	Bit 2	Bit 1	Bit 0
1	0	Diagnosis alarm	-	-	0	-	-	Format of values	
2	1	0	Channel 0 behavior at CPU-STOP			Channel 0 output range			
3	2	Channel 0 substitute value							
	3								
4	4	0	Channel 1 behavior at CPU-STOP			Channel 1 output range			
5	5	Channel 1 substitute value							
	6								
6	7	0	Channel 2 behavior at CPU-STOP			Channel 2 output range			
7	8	Channel 2 substitute value							
	9								
8	10	0	Channel 3 behavior at CPU-STOP			Channel 3 output range			
9	11	Channel 3 substitute value							
	12								

Diagnostic alarm: 1 = ON / 0 = OFF

Format of values: 0 = Simatic S7; 1 = Simatic S5; 2 = INT16

Output range: 0 = Disabled / 1 = ±10 V voltage / 2 = 0 ... 10 V voltage/
3 = 1 ... 5 V

Behavior at CPU-STOP 0 = Outputs de-energized / 1 = Retain last value / 2 = Apply substitute value

Substitute value: 16-bit analog value (±27648)

9. Alarms

9.1. Diagnostic IDs

Overview of all diagnostic IDs of the standard modules:

0 = There is no error / The error has been fixed

1 = Short circuit (to GND)

2 = Undervoltage

3 = Overvoltage

4 = Overload

5 = Excess temperature

6 = Line break / Wire break

7 = Overflow: Value falls above measuring range

8 = Underflow: Value falls below measuring range

16 = *Power module*: Bus supply voltage drop (overload / short circuit)

17 = L+ reference voltage missing

18 = Incorrect parameter configuration (*flashing red LED on module*)

9.2. Process alarms

9.2.1. Process alarms of the analog input modules

Process alarm data length: 2 bytes

Byte/ Bit	7	6	5	4	3	2	1	0
0	Channel 7 upper limit exceeded	Channel 6 upper limit exceeded	Channel 5 upper limit exceeded	Channel 5 upper limit exceeded	Channel 3 upper limit exceeded	Channel 2 upper limit exceeded	Channel 1 upper limit exceeded	Channel 0 upper limit exceeded
1	Channel 7 lower limit fallen below	Channel 6 lower limit fallen below	Channel 5 lower limit fallen below	Channel 4 lower limit fallen below	Channel 3 lower limit fallen below	Channel 2 lower limit fallen below	Channel 1 lower limit fallen below	Channel 0 lower limit fallen below



NOTE

Process alarms are not supported by all bus couplers. Please read the manual of the bus coupler in regard to whether and how the process alarms are supported.

10. Dimensions

Module with standard width

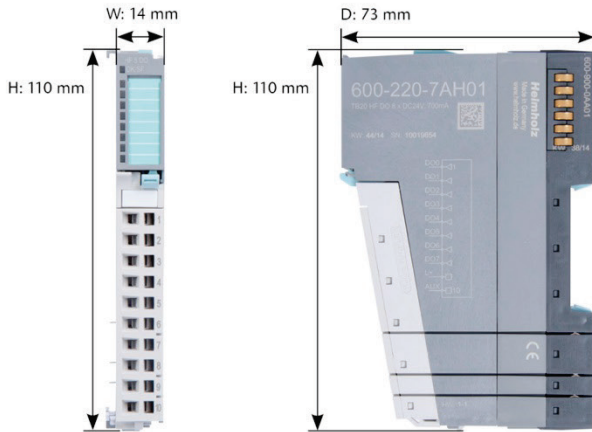

Module with double width

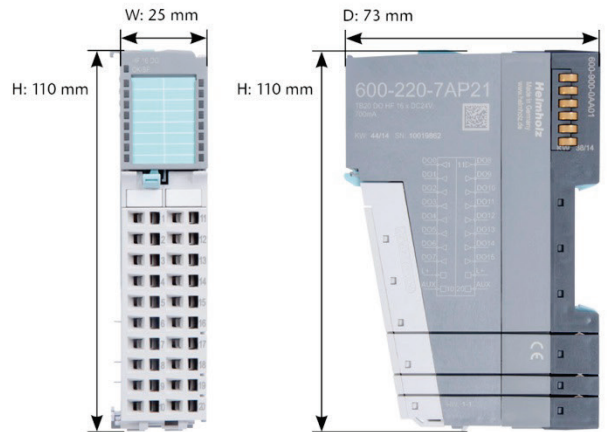

Communication Module

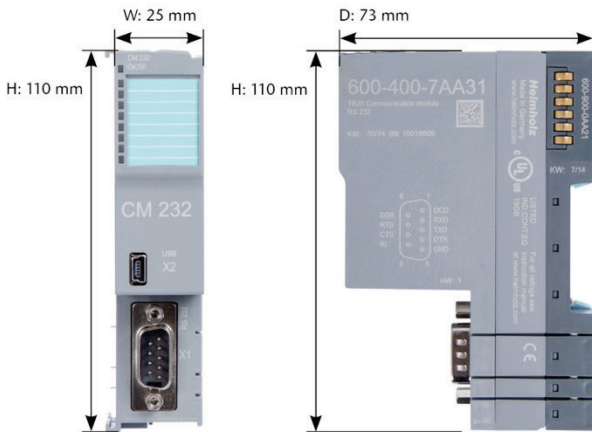

Bus Coupler

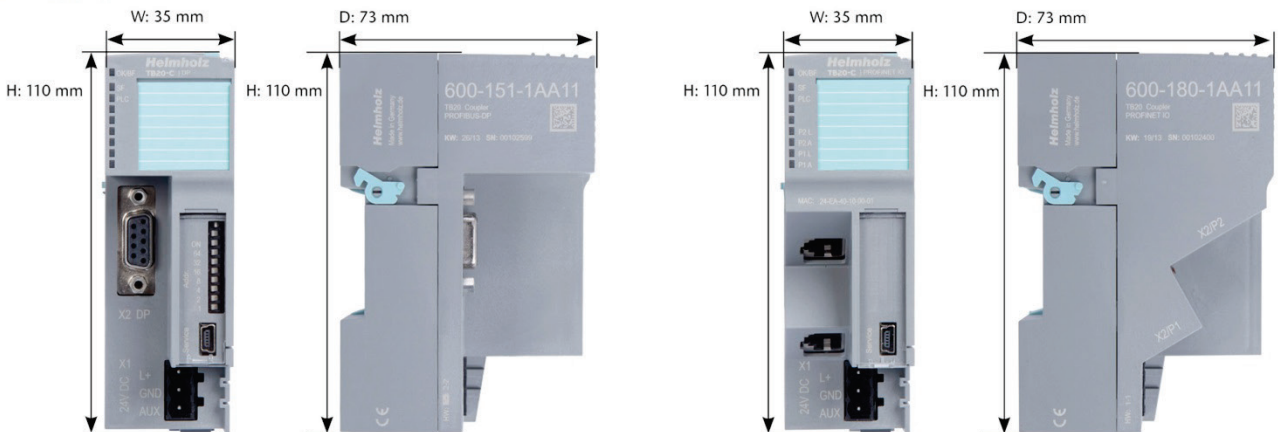

11. Spare parts

11.1. Base modules

11.1.1. 14 mm width standard base module

The 14 mm standard base module is available in sets of five with order no. 600-900-9AA01.



11.1.2. 25 mm width base module

The 25 mm standard base module is available in sets of five with order no. 600-900-9AA21.



11.1.3. Power and isolation base module

The power and isolation base module is available in sets of five with order no. 600-900-9BA01.



11.1.4. Power base module

The power base module is available in sets of five with order no. 600-900-9CA01.

It can be used with the power module (600-700-0AA01) and with all bus couplers.

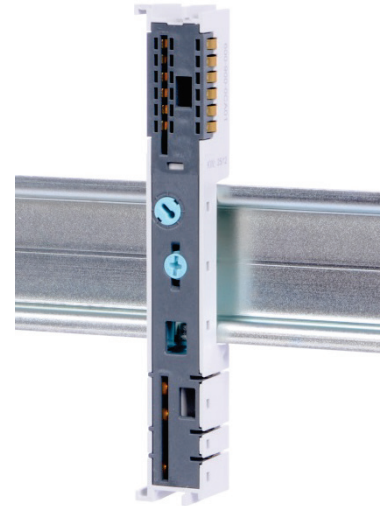

11.2. Front connectors

11.2.1. 10-terminal front connector

The 10-terminal front connector is available in sets of five with order no. 600-910-9AJ01.



11.2.2. 20-terminal front connector

The 20-pin front connector is available in sets of five with order no. 600-910-9AT21.



11.3. Electronic modules

Electronic modules can be ordered as spare parts with the order number of the original product. Electronic modules are always sent as a complete assembly, including the corresponding base module and front connector.

11.4. Final cover

The final cover is available in sets of five with order no. 600-920-9AA01.

